

LIST OF PARTS COMPLETE

FOR

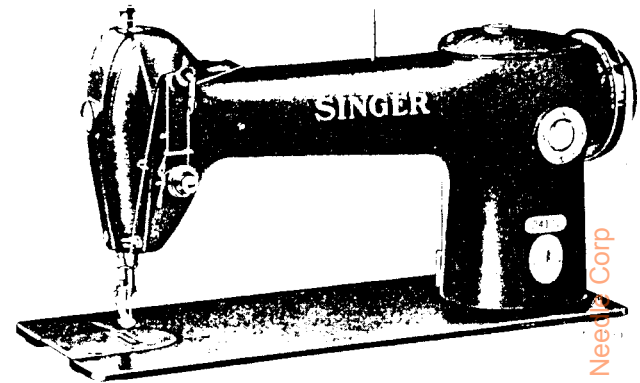

MACHINE No. 241-II

For Sewing Light and Medium Weight Fabrics. High Speed, Lock Stitch, Drop Feed Machine. Needle Bar Stroke $1\frac{1}{64}$ inches. Presser Bar Lift $\frac{9}{32}$ inch. Maximum length of stitch 7 to the inch. Speed up to 5000 R. P. M., according to the material being stitched.

No.	Plate	Name
*143262	-----	Arm with 15404 and two 143176.....
		Note: Due to the accuracy required for gear alignment, Arm cannot be supplied separately and can only be sent out as a unit, Arm and Bed Assembled.
8582	23272	Arm Dowel Pin (2).....
143002	23272	Arm Hole Plug (top of arm) for plugging hole used to assemble take-up oil wicks.....
868E	23272	Arm Screw (front) (2).....
140315E	23272	" " Stud (back) (2).....
143003	23272	" Shaft (horizontal).....
143232	-----	" " " 143003 with 143237 (for factory use only).....

PARTS FOR MACHINE No. 241-II

No.	Plate	Name
143233	-----	Arm Shaft (horizontal) 143003 with 140359E and 143238 (for Agents only).....
143008	23272	Arm Shaft (horizontal) Bushing (center).....
140296AL	23272	Arm Shaft (horizontal) Bushing (center) Set Screw.....
143117	23272	Arm Shaft (horizontal) Flanged Bushing (back).....
140297AL	23272	Arm Shaft (horizontal) Flanged Bushing (back) Set Screw.....
143309	23272	Arm Shaft (horizontal) Flanged Bushing (front).....
140331AL	23272	Arm Shaft (horizontal) Flanged Bushing (front) Set Screw.....
140411D	23272	Arm Shaft (horizontal) Screw (back).
140359E	23272	Arm Shaft (horizontal) Screw Plug (front).....
143236	23272	Arm Shaft (horizontal) Screw Plug (front) Washer (fibre).....
143013	23272	Arm Shaft (upright).....
143014	23272	Arm Shaft (upright) Bevel Gear (lower) right hand spiral with two 1259AL.....
		Note: When ordering No. 143014 Class No. of Machine must be stated.
1259AL	23272	Arm Shaft (upright) Bevel Gear (lower) Set Screw (2).....
143015	23272	Arm Shaft (upright) Bevel Gear (upper) left hand spiral with two 1259AL.....
		Note: When ordering No. 143015 Class No. of Machine must be stated.
1259AL	23272	Arm Shaft (upright) Bevel Gear (upper) Set Screw (2).....
143016	23272	Arm Shaft (upright) Bushing (lower).
140298AL	23272	Arm Shaft (upright) Bushing (lower) Set Screw.....
143017	23272	Arm Shaft (upright) Bushing (upper).
140298AL	23272	Arm Shaft (upright) Bushing (upper) Set Screw.....
143018	23272	Arm Side Shield.....
219J	23272	Arm Side Shield Screw.....
52239	23277	Arm Spool Pin and Thread Eyelet.....
8879	23277	Arm Spool Pin Washer (cloth).....
143203	23275	Arm Top Cover for 143204.....
143205	23275	Arm Top Cover for 143206.....
143204	23275	Arm Top Cover with Stitch Regulator Flunger complete, Nos. 218J, 64519, 143203 and 143207.....
143206	23275	Arm Top Cover with Stitch Regulator Flunger complete, when a longer spool pin (3 1/2 in. long) is required, Nos. 218J, 64519, 143205, 143207 and 143244.....
		Note: No. 143204 is regularly furnished with this Machine.

PARTS FOR MACHINE No. 241-II

9

No.	Plate	Name
143020	23275	Arm Top Cover Gasket (cork).....
51369R	23275	Arm Top Cover Screw (2).....
143244	23275	Arm Top Cover Spool (3 1/2 in. long) with Spool Rest.....
143207	23275	Arm Top Cover Stitch Regulator Plunger.....
140317J	23275	Arm Top Cover Stitch Regulator Flunger Hole Plug Screw for plugging the Flunger hole when the Flunger is removed to prevent tampering with the stitch set (For agents only).....
64519	23275	Arm Top Cover Stitch Regulator Flunger Spring.....
218J	23275	Arm Top Cover Stitch Regulator Flunger Stop Screw.....
143265	23275	Balance Wheel (disc, power) 2 3/16 in. diam. pulley, with two 140346AL, for Round Belt.....
143363	23275	Balance Wheel (disc, power) "V" Belt Groove (outside diameter of Belt Groove 2.9 in.) with two 51283AL, for "V" Belt.....
		Note: No. 143363 is regularly furnished with this machine.
140346AL	23275	Balance Wheel Set Screw for 143265 (2).....
51283AL	23275	Balance Wheel Set Screw for 143363 (2).....
*143263	-----	Bed.....
		Note: Due to the accuracy required for gear alignment, Bed cannot be supplied separately and can only be sent out as a unit Arm and Bed assembled.
143024	23272	Bed Hole Plug.....
143268	23272	Bed Leg (back).....
1518J	23272	Bed Leg (back) Nut (2).....
12431X	23277	Bed Slide.....
4307	23277	Bed Slide Spring.....
725X	23277	Bed Slide Spring Screw (2).....
12432	23277	Bed Slide complete, Nos. 4307, 12431 and two 725X.....
143292	-----	Combination of Feed and Stitch Regulator Parts, Nos. 143040, 143049, 143123, 143134, 143293 and 143294.....
143293	-----	Dummy Shaft for 143292.....
143228	23277	Face Plate.....
		Note: When ordering No. 143228, Class No. of Machine must be stated.
143229	23277	Face Plate Thread Guard (lower)....
50117J	23277	Face Plate Thread Guard (lower) Screw.....
143230	23277	Face Plate Thread Guard (upper)....

From the files of Watson Needle Co.

No.	Plate	Name
50117J	23277	Face Plate Thread Guard (upper) Screw.....
143231	23277	Face Plate complete, Nos. 143228 to 143230 and two 50117J.....
Note: When ordering No. 143231, Class No. of Machine must be stated.		
143061J	23277	Face Plate Screw (lower).....
143050J	23277	Face Plate Screw (upper).....
143030	23281	Feed Bar.....
51220AL	23281	Feed Bar Adjusting Screw (2).....
16070	23281	Feed Bar Adjusting Screw Lock Nut (2).....
143185	23281	Feed Bar Body with two each 16070 and 51220AL.....
7040	23281	Feed Bar Body Screw.....
143186	23281	Feed Bar Shank.....
143187	23281	Feed Bar (tilting, adjustable) complete, Nos. 7040, 143185 and 143186.....
Note: No. 143030 is regularly furnished with this machine.		
3130	23281	Feed Bar Screw Center (2).....
56813	-----	Feed Bar Screw Center 3130 with 1519J (2).....
1519J	23281	Feed Bar Screw Center Nut (2).....
143031	23281	Feed Bar Screw Center Oil Wick.....
143032	23281	Feed Bar Screw Center Oil Wick Holder.....
143033	23281	Feed Bar Screw Center Oil Wick Holder 143032 with 143031.....
226E	23281	Feed Bar Screw Center Oil Wick Holder Screw (2).....
52031	23277	Feed Dog 19 teeth (22 teeth to the inch) for 52032 and 52033.....
50117AL	23277	Feed Dog Screw (2).....
*143034	-----	Feed Eccentric.....
143123	23272	Feed Eccentric 143034 with 143035...
*143035	-----	Feed Eccentric Body with 1375AL and two 1036AL.....
1375AL	23272	Feed Eccentric Body Position Screw..
1036AL	23272	Feed Eccentric Body Set Screw (2)...
140256AL	23272	Feed Eccentric Stop Screw (7 stitch)
Note: No. 140256AL is regularly furnished with this Machine.		
140257AL	23272	Feed Eccentric Stop Screw (5 1/2 stitch).....
140258AL	23272	Feed Eccentric Stop Screw (14 stitch)
143036	23272	Feed Lifting Eccentric and Arm Shaft (horizontal) Bevel Gear, right hand spiral with 1036AL, 1375AL and 143088.....
1375AL	23272	Feed Lifting Eccentric Position Screw.....

No.	Plate	Name
1036AL	23272	Feed Lifting Eccentric Set Screw....
143269	23281	Feed Lifting Rock Shaft.....
143270	-----	Feed Lifting Rock Shaft complete, Nos. 143041 and 143269.....
143271	-----	Feed Lifting Rock Shaft 143270 with 143045 (For Agents only).....
143039	23281	Feed Lifting Rock Shaft Cap.....
223E	23281	Feed Lifting Rock Shaft Cap Screw (2).....
143040	23272	Feed Lifting Rock Shaft Connecting Rod.....
140230C	23272	Feed Lifting Rock Shaft Connecting Rod Hinge Screw.....
1518J	23272	Feed Lifting Rock Shaft Connecting Rod Hinge Screw Nut.....
143041	23281	Feed Lifting Rock Shaft Crank with 157J, 50579J, 52267 and 143044....
157J	23281	Feed Lifting Rock Shaft Crank Clamping Screw.....
52267	23281	Feed Lifting Rock Shaft Crank Slide Block with Stud
143042	23281	Feed Lifting Rock Shaft Crank Slide Block Oil Wick.....
143043	23281	Feed Lifting Rock Shaft Crank Slide Block Oil Wick Holder.....
143044	23281	Feed Lifting Rock Shaft Crank Slide Block Oil Wick Holder 143043 with 143042.....
50579J	23281	Feed Lifting Rock Shaft Crank Slide Block Oil Wick Holder Screw.....
50191C	23281	Feed Lifting Rock Shaft Screw Center (2).....
52097	-----	Feed Lifting Rock Shaft Screw Center 50191C with 1513J (2).....
143045	23281	Feed Lifting Rock Shaft Screw Center Front Oil Wick.....
1513J	23281	Feed Lifting Rock Shaft Screw Center Nut (2).....
143046	23281	Feed Rock Shaft.....
143047	-----	Feed Rock Shaft complete, Nos. 143046 and 143050.....
143221	-----	Feed Rock Shaft 143047 with 143051 (For Agents only).....
143048	23281	Feed Rock Shaft Cap.....
223E	23281	Feed Rock Shaft Cap Screw (2).....
143049	23272	Feed Rock Shaft Connecting Rod.....
140230C	23272	Feed Rock Shaft Connecting Rod Hinge Screw.....
1518J	23272	Feed Rock Shaft Connecting Rod Hinge Screw Nut.....
143050	23281	Feed Rock Shaft Crank with 157J....
157J	23281	Feed Rock Shaft Crank Clamping Screw
50191C	23281	Feed Rock Shaft Screw Center (left)
52097	-----	Feed Rock Shaft Screw Center (left) 50191C with 1513J.....

From the Illinois State Library of Digital Collections

No.	Plate	Name
140278C	23281	Feed Rock Shaft Screw Center (right)
143138	-----	Feed Rock Shaft Screw Center (right) 140278C with 1513J.....
143051	23281	Feed Rock Shaft Screw Center Front Oil Wick.....
143052	23281	Feed Rock Shaft Screw Center Front Oil Wick Holder.....
143053	23281	Feed Rock Shaft Screw Center Front Oil Wick Holder 143052 with 143045 and 143051.....
228E	23281	Feed Rock Shaft Screw Center Front Oil Wick Holder Screw.....
1513J	23281	Feed Rock Shaft Screw Center Nut (2)
25878	23277	Guide.....
50190J	23277	Guide Thumb Screw.....
143335	23286	Needle Bar (hollow) with 140239AL...
143336	23286	Needle Bar Bushing (lower).....
1133E	23286	Needle Bar Bushing (lower) Set Screw
52171	23286	Needle Bar Bushing (lower) Thread Eyelet.....
143324	23286	Needle Bar Bushing (upper).....
1133E	23286	Needle Bar Bushing (upper) Set Screw
143054	23286	Needle Bar Connecting Link.....
143325	-----	Needle Bar Connecting Link 143054 with 143326.....
140231C	23286	Needle Bar Connecting Link Cap Screw
143056	23286	Needle Bar Connecting Link Roller Bearing (18).....
143326	23286	Needle Bar Connecting Stud with 207E
207E	23286	Needle Bar Connecting Stud Clamping Screw.....
143058	23286	Needle Bar Connecting Stud Slide Block.....
143237	23272	Needle Bar Crank with 1036AL, 1065AL and 140327AL.....
143238	-----	Needle Bar Crank 143237 with 143236 and 143241 (For Agents only)
1065AL	23272	Needle Bar Crank Position Screw....
143196	23286	Needle Bar Oil Wick.....
140239AL	23286	Needle Set Screw.....
143060	23212	Oil Flow Body.....
143061	23212	Oil Flow Body Gasket (2).....
143062	23212	Oil Flow Window.....
143063	23212	Oil Flow Window Cap.....
50257J	23212	Oil Flow Window Cap Screw (4).....
143116	23212	Oil Lead.....
51369E	23212	Oil Lead Screw.....
143064	23212	Oil Pipe for 143067.....
143065	23212	Oil Pipe Clamping Sleeve (2).....
143066	23212	Oil Pipe Clamping Sleeve Nut (2)....
143067	23212	Oil Pipe complete from Oil Pump to Arm Shaft (horizontal) Center Bearing, Nos. 143064 and two each 143065 and 143066 (For Agents only)

No.	Plate	Name
143068	23212	Oil Pipe with 143124 for oiling Rotating Hook Shaft Front Bearing (For Agents only).....
143124	23212	Oil Pipe Clamping Sleeve.....
143125	23212	Oil Pipe Clamping Sleeve Nut.....
143126	23212	Oil Pipe Clamping Sleeve Nut Adaptor
143070	23212	Oil Pump (centrifugal) Body with 143126.....
143071	23212	Oil Pump (centrifugal) Body Position Pin (2).....
157E	23212	Oil Pump (centrifugal) Body Screw (3).....
143072	23212	Oil Pump (centrifugal) Cover.....
143073	23212	Oil Pump (centrifugal) Impeller....
50123E	23272	Oil Pump (centrifugal) Impeller Locking Screw.....
143074	23212	Oil Pump (centrifugal) Screen.....
143075	23212	Oil Pump (centrifugal) Screen Frame.
189E	23212	Oil Pump (centrifugal) Screen Frame Screw (4).....
143197	23272	Oil Wick, for oiling, Needle Bar Connecting Link, Thread Take-up Lever, Thread Take-up Lever Hinge Bearing and Thread Take-up Lever Link.....
143077	23272	Oil Wick Holder complete, Nos. 143197 and 143200.....
140232J	23272	Oil Wick Holder Screw.....
143200	23272	Oil Wick Oil Leader.....
143337	23286	Presser Bar (Hollow).....
143184	23286	Presser Bar Bushing (lower).....
1133E	23286	Presser Bar Bushing (lower) Set Screw.....
143338	23286	Presser Bar Guide Bracket with 143330 and 453AL.....
453AL	23286	Presser Bar Guide Bracket Set Screw.
52016	23286	Presser Bar Lifter.....
143079	23286	Presser Bar Lifter Hinge Stud.....
448AL	23286	Presser Bar Lifter Hinge Stud Set Screw.....
12327	23286	Presser Bar Lifting and Releasing Lever Bracket.....
143127	23286	Presser Bar Spring.....
11170	23286	Presser Bar Spring Washer.....
62527	23286	Presser Foot Hinge Pin.....
62925	23286	Presser Foot Plate.....
62926	23286	Presser Foot Shank.....
26231	23286	Presser Foot Spring.....
62927	23286	Presser Foot (spring hinged) complete, Nos. 26231, 62527, 62925 and 62926.....
140390AL	23286	Presser Foot Screw.....
143339	23286	Pressure Regulating Thumb Screw and Presser Bar Guide.....
143340	23286	Rotating Hook with 143301 and two 1253AL.....

No.	Plate	Name
143341	-----	Rotating Hook 143340 with 143351, 270083 and four 1053E.....
143342	-----	Rotating Hook 143341 with 40274, 143346 and three 1367E.....
143343	-----	Rotating Hook 143341 with 40274 and three 1367E (For Agents only)....
143344	23286	Rotating Hook 143342 with 52237.....
40264	23286	Rotating Hook Bobbin (2).....
52235	23286	Rotating Hook Bobbin Case.....
52236	-----	Rotating Hook Bobbin Case 52235 with 591F, 1380E and 40394.....
40392	23286	Rotating Hook Bobbin Case Latch.....
125320	23286	Rotating Hook Bobbin Case Latch Lever.....
2974	23286	Rotating Hook Bobbin Case Latch Lever Fulcrum Pin.....
2975	23286	Rotating Hook Bobbin Case Latch Spring.....
592E	23286	Rotating Hook Bobbin Case Latch Stop Screw.....
40393	23286	Rotating Hook Bobbin Case Hinge, Nos. 2974, 40392 and 125320.....
591F	23286	Rotating Hook Bobbin Case Tension Regulating Screw.....
40394	23286	Rotating Hook Bobbin Case Tension Spring.....
1380E	23286	Rotating Hook Bobbin Case Tension Spring Screw.....
52237	23286	Rotating Hook Bobbin Case complete, Nos. 592E, 2975, 40393 and 52236..
143345	-----	Rotating Hook Bobbin Case 52237 with 143346 (For Agents only).....
143346	23286	Rotating Hook Bobbin Case Holder....
52018	23281	Rotating Hook Bobbin Case Holder Position Bracket.....
704J	23281	Rotating Hook Bobbin Case Holder Position Bracket Screw.....
140316C	23281	Rotating Hook Oil Flow Regulating Screw.....
143182	23281	Rotating Hook Oil Flow Regulating Screw Body.....
51701C	23281	Rotating Hook Oil Flow Regulating Screw Body Lock Nut.....
143183	23281	Rotating Hook Oil Flow Regulator complete, Nos. 51701C, 140316C and 143182.....
143301	-----	Rotating Hook Oil Wick (felt).....
40274	23286	Rotating Hook Section.....
1367E	23286	Rotating Hook Section Screw (3)....
1253AL	23286	Rotating Hook Set Screw (2).....
143347	23281	Rotating Hook Shaft with 143350....
143348	-----	Rotating Hook Shaft 143347 with 143133.....
143081	23281	Rotating Hook Shaft Bevel Gear (left hand spiral) with two 1259AL.....

No.	Plate	Name
1259AL	23281	Rotating Hook Shaft Bevel Gear Set Screw (2).....
143082	23281	Rotating Hook Shaft Bushing (back)..
140259C	23281	Rotating Hook Shaft Bushing (back) Set Screw.....
143083	23281	Rotating Hook Shaft Bushing (front)..
1285AL	23281	Rotating Hook Shaft Bushing (front) Set Screw.....
143042	23281	Rotating Hook Shaft Oil Filter Wick.
143349	23281	Rotating Hook Shaft Oil Filter Wick Holder.....
143350	23281	Rotating Hook Shaft Oil Filter complete, Nos. 143042 and 143349..
143133	23281	Rotating Hook Shaft Oil Sling with two 50429AL.....
50429AL	23281	Rotating Hook Shaft Oil Sling Set Screw (2).....
270083	23286	Rotating Hook Thread Guard.....
1053E	23286	Rotating Hook Thread Guard Screw (4)
143351	-----	Rotating Hook Wiper.....
143294	-----	Set of Mated Gears complete for upper shaft, Nos. 143015, 143036 and 143087.....
143295	-----	Set of Mated Gears complete for lower shaft, Nos. 143014 and 143088
143201	23286	Slack Thread Regulator.....
223C	23286	Slack Thread Regulator Set Screw....
143085	23272	Stitch Regulator.....
143134	-----	Stitch Regulator 143085 with 140380E, 143086 and 143089.....
143086	23272	Stitch Regulator Locking Slide.....
143087	23272	Stitch Regulator Locking Slide Ratchet Wheel.....
143088	-----	Stitch Regulator Locking Slide Ratchet Wheel Pin.....
143089	23272	Stitch Regulator Locking Slide Spring.....
140380E	23272	Stitch Regulator Locking Slide Spring Screw.....
50617R	23272	Stitch Regulator Plunger Hole Plug Screw.....
701872R	23272	Stitch Regulator Plunger Hole Plug Screw Washer.....
217E	23272	Stitch Regulator Plunger Spring Screw Hole Plug Screw.....
2102	23277	Tension Disc (2).....
1560C	23277	Tension Regulating Thumb Nut.....
32572	23277	Tension Releasing Disc.....
43944	23277	Tension Releasing Lever.....
12398	23277	Tension Releasing Lever Hinge Pin...
12329	23277	Tension Releasing Lever Spring.....
32574	23277	Tension Releasing Pin.....
2103	23277	Tension Spring.....
50304C	23277	Tension Stud.....
52098	-----	Tension Stud 50304C with 1560C.....

MACHINE No. 241-I2

For Sewing Medium and Medium Heavy Fabrics. High Speed, Lock Stitch, Drop Feed Machine. Needle Bar Stroke $1\frac{13}{64}$ inches. Presser Bar Lift $\frac{5}{16}$ inch. Maximum length of stitch $5\frac{1}{2}$ to the inch. Speed up to 5000 R. P. M., according to the material being stitched.

NOTE: THIS MACHINE IS THE SAME AS THE NO. 241-II

MACHINE, WITH THE FOLLOWING EXCEPTIONS:

No.	Plate	Name
50305C	23277	Tension Stud Set Screw.....
52397	23277	Tension complete, Nos. 2103, 32572, 32574, 52083, 52098, 52394 and two 2102.....
143135	23277	Thread Guard (side of arm).....
52454	23277	Thread Retainer.....
624AL	23277	Thread Retainer Set Screw.....
143329	23286	Thread Take-up complete, Nos. 143097 to 143099, 143330 and eighteen 143056.....
143330	23286	Thread Take-up Crank with 140231C, 143058, 143325 and eighteen 143056
140327AL	23272	Thread Take-up Crank Clamping Screw.
1036AL	23272	Thread Take-up Crank Set Screw.....
143241	23272	Thread Take-up Crank Wearing Plate..
143152	-----	Thread Take-up Lever with 52130, 143098 and eighteen 143056 (For Agents only).....
52023	23286	Thread Take-up Lever Hinge Stud....
143096	23286	Thread Take-up Lever Link.....
143097	23286	Thread Take-up Link Hinge Stud.....
435AL	23286	Thread Take-up Lever Link Hinge Stud Set Screw.....
143202	23286	Thread Take-up Lever Oil Guard with 143196.....
217E	23286	Thread Take-up Lever Oil Guard Screw
143056	23286	Thread Take-up Lever Roller Bearing (18).....
143098	23286	Thread Take-up Lever Roller Bearing Retaining Washer.....
52130	23286	Thread Take-up Lever Thread Eyelet Bushing.....
143099	-----	Thread Take-up Lever complete, Nos. 52023 and 143096.....
52394	23277	Thread Take-up Spring.....
52083	23277	Thread Take-up Spring Regulator with 50305C.....
443AL	23277	Thread Take-up Spring Regulator Set Screw.....
52032XC	-----	Throat Plate (large needle hole) for 52031.....
52033XC	23277	Throat Plate (small needle hole) for 52031.....
Note: No. 52033 is sent with this Machine unless otherwise specified on order.		
691XC	23277	Throat Plate Screw (2).....
*15404	-----	Trade Mark.....
143176	-----	Trade Mark Rivet (2).....

No.	Plate	Name
143234	-----	Arm Shaft (horizontal) 143003 with 143239, in place of 143232 (For Factory use only).....
143235	-----	Arm Shaft (horizontal) 143003 with 140359E and 143240 (For Agents only) in place of 143233.....
127319	23278	Feed Dog, 19 teeth (16 teeth to the inch) for 127320 and 127321, in place of 52031.....
140257AL	23273	Feed Eccentric Stop Screw (5 1/2 stitch) in place of 140256AL.....
143321	23287	Needle Bar (hollow) in place of 143335.....
143322	-----	Needle Bar 143321 with 665J, 143327 and 143328.....
143323	23287	Needle Bar Bushing (lower) in place of 143336.....
143239	23273	Needle Bar Crank with 1036AL, 1065AL and 140327AL in place of 143237..
143240	-----	Needle Bar Crank 143239 with 143236 and 143241 (For Agents only) in place of 143238.....
143327	23287	Needle Bar Thread Guard for 143322..
665J	23287	Needle Bar Thread Guard Screw for 143322.....
143328	23287	Needle Clamp with 140119AL for 143322.....
140119AL	23287	Needle Clamp Screw for 143328.....
143151	23273	Oil Wick Holder complete Nos. 143197 and 143200, in place of 143077....
7298	23287	Presser Foot Hinge Pin for 19336....
19334	23287	Presser Foot Plate for 19336.....
19335	23287	Presser Foot Shank for 19336.....
19336	23287	Presser Foot (hinged) complete Nos. 7298, 19334 and 19335, in place of 62927.....
* 127320XC	23278	Throat Plate (large needle hole) for 127319, in place of 52032.....
127321XC	-----	Throat Plate (small needle hole) for 127319, in place of 52033.....
Note: No. 127320 is sent with this Machine unless otherwise specified on order.		

From the original of Diamond Needle Co.

MACHINE No. 241-13

For Sewing Heavy and Extra Heavy Fabrics. High Speed,
Lock Stitch, Drop Feed Machine. Needle Bar Stroke $1 \frac{7}{16}$ inches.
Presser Bar Lift $\frac{3}{8}$ inch. Maximum length of stitch $5 \frac{1}{2}$ to the inch.
Speed up to 4300 R. P. M., according to the material being stitched.

NOTE: THIS MACHINE IS THE SAME AS THE NO. 241-11

MACHINE, WITH THE FOLLOWING EXCEPTIONS:

No.	Plate	Name
143234	-----	Arm Shaft (horizontal) 143003 with 143239, in place of 143232 (For Factory use only).....
143235	-----	Arm Shaft (horizontal) 143003 with 140359E and 143240 (For Agents only) in place of 143238.....
143174	23279	Feed Dog (17 teeth) (14 teeth to the inch) for 143175, in place of 52031
140257AL	23274	Feed Eccentric Stop Screw (5 1/2 stitch) in place of 140256AL
143321	23288	Needle Bar (hollow) for 143322.....
143361	-----	Needle Bar (hollow) for 143362.....
143322	-----	Needle Bar 143321 with 665J, 143327 and 143328 in place of 143335.....
143362	-----	Needle Bar 143361 with 665J, 143327 and 143328 for size 16 x 182 needle.....
Note: Needle Bar 143322 is sent with this machine unless otherwise specified on order.		
143323	23288	Needle Bar Bushing (lower) in place 143336.....
143239	23274	Needle Bar Crank with 1036AL, 1065AL and 140327AL, in place of 143237...
143240	-----	Needle Bar Crank 143239 with 143236 and 143241 (For Agents only) in place of 143238.....
143327	23288	Needle Bar Thread Guard.....
665J	23288	Needle Bar Thread Guard Screw.....
143328	23288	Needle Clamp with 140119AL.....
140119AL	23288	Needle Clamp Screw.....
143147	23274	Oil Wick Holder complete Nos. 143197 and 143200, in place of 143077.....
5990	23288	Presser Bar Lifter, in place of 52016
127233	23288	Presser Foot Plate for 127234.....
52390	23288	Presser Foot Shank for 127234.....
26231	23288	Presser Foot Spring for 127234.....
127234	23288	Presser Foot (spring hinged) complete Nos. 26231, 52390, 62527 and 127233, in place of 62927.....
52445	23279	Tension Releasing Lever, in place of 43944.....

No.	Plate	Name
143334	23288	Thread Take-up complete Nos. 143097 to 143099, 143332 and eighteen 143056, in place of 143329.....
143337	23288	Thread Take-up Crank with 140231C, 143058, 143325 and eighteen 143056, in place of 143330.....
143153	-----	Thread Take-up Lever with 50130, 143098 and eighteen 143056 (For Agents only) in place of 143152..
143175XC	23279	Throat Plate, in place of 52033.....

NUMERICAL LIST OF PARTS

No.	Plate	Name
9D	23260	Tucker Tuck Guide Bracket Spring Screw for 36394.....
24J	24354	Hemmer Hinge Screw for 121927.....
157J	23281	Feed Lifting Rock Shaft Crank Clamping Screw for 143041.....
157J	23281	Feed Rock Shaft Crank Clamping Screw for 143050.....
157E	23212	Oil Pump (centrifugal) Body Screw (3).....
158R	23281	Bell Crank Bracket Screw for 143289 (2).....
189E	23212	Oil Pump (centrifugal) Screen Frame Screw (4).....
190D	23226	Binder Ribbon Tension Screw for 26250.....
190J	23228	Corder Cord Guide Screw for 120207..
190J	22920	Piping Attachment Screw for 120742 (2).....
190J	23293	Roller Presser Screw for 19464....
193D	23227	Binder Folder Screw for 28776.....
196J	23227	Finger Guard Holder Set Screw for 36820.....
207F	23266	Binder Folder Screw for 26250.....
207E	23286	Needle Bar Connecting Stud Clamping Screw for 143326.....
207F	23268	Quilter Guide Holder Set Screw for 25992.....
207F	23268	Quilter Guide Set Screw for 25992..
208AL	23289	Thread Unwinder Thread Guide Rod Screw for 225324.....
209C	23268	Quilter Guide Bracket Set Screw for 120482.....
209C	23268	Quilter Guide Set Screw for 120482..
217J	22920	Piping Attachment Adjusting Screw for 120737.....
217E	23272	Stitch Regulator Plunger Spring Screw Hole Plug Screw.....
217E	23286	Thread Take-up Lever Oil Guard Screw
218J	23275	Arm Top Cover Stitch Regulator Plunger Stop Screw for 143204 and 143206.....
219J	23272	Arm Side Shield Screw.....
223E	23281	Feed Lifting Rock Shaft Cap Screw (2).....
223E	23281	Feed Rock Shaft Cap Screw (2).....
223C	23286	Slack Thread Regulator Set Screw for 143338.....
228E	23281	Feed Bar Screw Center Oil Wick Holder Screw (2).....
228E	23281	Feed Rock Shaft Screw Center Front Oil Wick Holder Screw.....
228J	23236	Presser Foot Extension Screw for 12435, 20157 and 160346 to 160348.

SINGER Needles should be used
in SINGER Machines
These Needles and their Containers
are marked with the
Company's Trade Mark "SIMANCO.**" 1

Needles in Containers marked
"FOR SINGER MACHINES"
are NOT SINGER made needles. 2

NUMERICAL LIST OF PARTS

No.	Plate	Name
233W	23227	Presser Foot Strip Gauge Screw for 139618.....
233W	23227	Binder Ribbon Tension Screw for 28776 (2).....
233L	23236	Presser Foot Guide Set Screw for 33714.....
234E	24356	Hammer (Foot) Extension Guide Screw for 160321 (2).....
236J	23227	Finger Guard Screw for 121562 (2)...
239E	23285	Presser Foot Thread Cutter Screw for 127260.....
245B	23291	Ruffler Ribbon Guide Screw for 121123.....
247C	23260	Tucker Tuck Guide Bracket Screw Center for 56814 (2).....
313C	23281	Feed Bar Screw Center for 56813 (2).
327B	23233	Hammer Scroll (lower) Spring Position Screw for 121665 and 121669.....
337J	23197	Presser Foot Edge Guide Screw for 121647 (2).....
337J	24351	Presser Foot Edge Guide (left hand) Screw for 160340 (2).....
337B	24356	Presser Foot Graduated Adjustable Guide Clamp Screw for 121949.....
337J	24351	Presser Foot Marker Guide (right hand) Screw for 160340 (2).....
356C	23284	Knee Lifter Rock Shaft Knee Arm Plate Set Screw for 2767.....
356C	23284	Knee Lifter Rock Shaft Knee Arm Set Screw for 143284.....
402D	23260	Tucker Space Guide Base Screw for 36395 (2).....
423AL	23260	Tucker Tuck Guide Bracket Stop Screw for 36394.....
435AL	23286	Thread Take-up Lever Link Hinge Stud Set Screw.....
443AL	23277	Thread Take-up Spring Regulator Set Screw.....
448AL	23281	Lifting Lever Pin Set Screw for 143242.....
448AL	23286	Presser Bar Lifter Hinge Stud Set Screw.....
453AL	23286	Presser Bar Guide Bracket Set Screw for 143356.....
456C	23298	Roller Arm Bracket Position Collar Set Screw for 19443.....
457AL	23228	Corder Cord Guide Bed Leveling Screw for 120206.....
465F	23300	Edge Guide Bed Leveling Screw for 36187 (4).....
569B	23291	Ruffler Driving Lever Adjusting Thumb Screw (upper) for 121121....
590D	23296	Hammer Adjusting Screw for 35540 (2)

NUMERICAL LIST OF PARTS

57

No.	Plate	Name
591F	23286	Rotating Hook Bobbin Case Tension Regulating Screw for 52236.....
592E	23286	Rotating Hook Bobbin Case Latch Stop Screw for 52237.....
602D	23268	Quilter Guide Disengaging Sleeve Spring Screw for 120485.....
624AL	23277	Thread Retainer Set Screw.....
665J	23287	Needle Bar Thread Guard Screw for 143322 and 143362.....
665J	23285	Presser Foot Shank Adjusting Screw for 127258.....
665J	23236	Presser Foot Spring Guide Screw for 28726, 28909, 36465 and 139630....
691XC	23277	Throat Plate Screw (2).....
704C	23281	Feed Bar Body Screw for 143187.....
704J	23281	Rotating Hook Bobbin Case Holder Position Bracket Screw.....
724F	23276	Binder Releasing Lever Hinge Screw for 121737 and 121890.....
725X	23277	Bed Slide Spring Screw for 12432 (2)
766E	23286	Lifting Lever Link Hinge Screw for 143289.....
802D	23281	Lifting Lever Hinge Screw for 143289
803C	23260	Tucker Tuck Guide Frame Stop Screw for 36394.....
868E	23272	Arm Screw (front) (2).....
940F	23276	Binder Throw-out Arm Hinge Screw for 121737 and 121890.....
940W	24352	Hammer on Shank Holder Hinge Screw for 160326.....
987E	23298	Roller Arm Bracket Screw Stud for 24445.....
1036AL	23272	Feed Eccentric Body Set Screw for 143035 (2).....
1036AL	23272	Feed Lifting Eccentric Set Screw for 143036.....
1036AL	23272	Thread Take-up Crank Set Screw for 143237 and 143239.....
1044D	23228	Corder Cord Guide Arm Hinge Screw for 120207.....
1053E	23286	Rotating Hook Thread Guard Screw for 143341 (4).....
1065AL	23272	Needle Bar Crank Position Screw for 143237 and 143239.....
1115F	23260	Tucker Tuck Guide Screw for 36394 (2).....
1133E	23286	Needle Bar Bushing (lower) Set Screw
1133E	23286	Needle Bar Bushing (upper) Set Screw
1133E	23286	Presser Bar Bushing (lower) Set Screw.....
1177J	23260	Tucker Tuck Guide Arm Screw for 36394 (2).....
1253AL	23286	Rotating Hook Set Screw for 143340 (2).....

NUMERICAL LIST OF PARTS

NUMERICAL LIST OF PARTS

No.	Plate	Name
1259AL	23272	Arm Shaft (upright) Bevel Gear (lower) Set Screw for 143014 (2)...
1259AL	23272	Arm Shaft (upright) Bevel Gear (upper) Set Screw for 143015 (2)...
1259AL	23281	Rotating Hook Shaft Bevel Gear Set Screw for 143081 (2).....
1259AL	23281	Rotating Hook Shaft Bushing (front) Set Screw.....
1257E	23286	Rotating Hook Section Screw for 143342 and 143343 (3).....
1258AL	23272	Feed Eccentric Body Position Screw for 143035.....
1258AL	23272	Feed Lifting Eccentric Position Screw for 143036.....
1259E	23286	Rotating Hook Bobbin Case Tension Spring Screw for 52236.....
1425D	23300	Edge Guide Arm Hinge Screw for 36188.....
1426E	23260	Tucker Space Guide Stop (left) Screw Stud for 35510.....
1426E	23260	Tucker Space Guide Stop (right) Screw Stud for 35510.....
1444J	23276	Binder Screw for 121737 and 121890 (2).....
1444B	23296	Hemmer Screw for 35540, 121841, 121842, 121888 and 121980 (2).....
1444J	23292	Piping Attachment Screw for 35245...
1499J	24354	Hemmer Screw for 121924 and 121926 (2).....
1510E	23260	Tucker Tuck Guide Frame Spring Nut for 36394.....
1513J	23281	Feed Lifting Rock Shaft Screw Center Nut for 52097 (2).....
1513J	23281	Feed Rock Shaft Screw Center Nut for 52097 and 143138 (2).....
1517J	23260	Tucker Tuck Guide Bracket Screw Center Nut for 56814 (2).....
1518J	23272	Bed Leg (back) Nut (2).....
1518J	23272	Feed Lifting Rock Shaft Connecting Rod Hinge Screw Nut.....
1518J	23272	Feed Rock Shaft Connecting Rod Hinge Screw Nut.....
1519J	23281	Feed Bar Screw Center Nut for 56813 (2).....
1520J	23260	Tucker Tuck Guide Bracket Stop Screw Nut for 36394.....
1520J	23260	Tucker Tuck Guide Frame Stop Screw Nut for 36394.....
1528J	23298	Roller Screw Nut for 51901.....
1560C	23277	Tension Regulating Thumb Nut for 52098.....
1607C	23261	Feed Bar Adjusting Screw Lock Nut for 143185 (2).....
1611J	23281	Lifting Lever Connecting Rod Nut for 143289.....
1611J	23281	Lifting Lever Connecting Rod Nut Lock Nut for 143289.....

No.	Plate	Name
1657D	23260	Tucker Space Guide Stop (left) Thumb Nut for 36388.....
1657D	23260	Tucker Space Guide Stop (right) Thumb Nut for 36388.....
1700J	23291	Ruffler Driving Lever Hinge Screw Nut for 121123.....
1772J	23291	Ruffler Ruffling Blade Holder Hinge Screw Nut for 121123.....
1941	23291	Ruffler Roller for 121451.....
1988	23300	Edge Guide Arm Roller and Screw Stud for 36185.....
2102	23253	Bobbin Winder Tension Disc for 225462 (2).....
2102	23277	Tension Disc for 52397 (2).....
2103	23277	Tension Spring for 52397.....
2656	-----	Presser Foot Spring for 160340.....
2767	23284	Knee Lifter Rock Shaft Knee Arm Plate with 356C for 143285.....
2974	23286	Rotating Hook Bobbin Case Latch Lever Fulcrum Pin for 40393.....
2975	23286	Rotating Hook Bobbin Case Latch Spring for 52237.....
3146	23293	Binder Thumb Screw Washer for 121868 and 121871.....
3146	22920	Binder (transverse) on Shank Thumb Screw Washer for 120742.....
4307	23277	Bed Slide Spring, for 12432.....
5990	23288	Presser Bar Lifter for 241-13 Machine.....
7071	23226	Binder Folder Screw Washer for 26250 and 28776.....
7071	23226	Binder Ribbon Tension Screw Washer for 26250.....
7071	24352	Hemmer on Shank Thumb Screw Washer for 160326.....
7071	22920	Piping Attachment Screw Washer, for 120742 (2).....
7298	23287	Presser Foot Hinge Pin for 19336, 20361, 120144 and 121660.....
8068	23280	Face Plate Thread Lubricator Oil Reservoir Rivet Washer (inside) for 143356.....
8582	23272	Arm Dowel Pin (2).....
8879	23277	Arm Spool Pin Washer (cloth).....
8879	23293	Tape Reel Disc Pin Washer (cloth) for 121412.....
8908	23248	Wrench for 1519 (Accessories).....
8909	23248	Wrench for 1513 and 1518 (Accessories).....
9374	23290	Machine Base and Oil Reservoir Frame Cushion Pin for 143306 (4).....
11170	23286	Presser Bar Spring Washer.....
12143	23225	Presser Foot for use with 44136 and 44137.....

For the Library of Diamond Needle Corp

NUMERICAL LIST OF PARTS

No.	Name
12340	23281 Lifting Lever Pin for 143289.....
12341	23286 Lifting Lever Link, for 143289.....
12398XC	23288 Throat Plate (large needle hole) for darning, for use with 160342.....
12327	23286 Presser Bar Lifting and Releasing Lever Bracket.....
12329	23277 Tension Releasing Lever Spring.....
12325	23286 Presser Foot (narrow).....
12361	23248 Machine Hinge Connection (Accessories) (2).....
12370	23227 Feed Dog, 15 teeth (16 teeth to the inch) for 28778.....
12398	23277 Tension Releasing Lever Hinge Pin...
12422XC	23285 Throat Plate (small needle hole), for darning for use with 160342...
12431X	23277 Bed Slide for 12432.....
12432	23277 Bed Slide complete, Nos. 4307, 12431X and two 725X.....
12435	23286 Presser Foot with 228J(with needle hole on right hand side) for 3/32 in. stitching margin.....
12436	23298 Feed Dog, 11 teeth (18 teeth to the inch) for use with 62861, for 20192.....
12450	23300 Feed Dog, 11 teeth (18 teeth to the inch) for use with Edge Folder on Shank No. 35175, for 12464.....
12462	23236 Presser Foot for 1/8 in. to 1 in. stitching margin.....
12463	23236 Presser Foot with strip guide.....
12464XC	23290 Throat Plate (large needle hole) for use with Edge Folder on Shank No. 35175, for 12450.....
12481	23282 Feed Dog, 18 teeth (16 teeth to the inch) for use with 160333, for 12482 (Boston) and for 12483 for 241-11 Machine.....
12482XC	23282 Throat Plate, for 12481 (Boston)....
12483XC	24357 Throat Plate for use with 160333, for 12481 for 241-11 Machine.....
13710	23253 Bobbin Winder Tension Spring for 225462.....
15404	----- Trade Mark for 143262.....
16555	23290 Machine Base and Oil Reservoir Frame Hinge Plate for 143306 (2).....
17718	23260 Tucker Space Guide Stop (left) Thumb Nut Washer for 36388.....
17718	23260 Tucker Space Guide Stop (right) Thumb Nut Washer for 36388.....
17822	23280 Face Plate Thread Lubricator Oil Reservoir Rivet for 143356.....
19223	23226 Presser Foot Shank for 20134 and 121660.....
19334	23287 Presser Foot Plate for 19336.....

NUMERICAL LIST OF PARTS

No.	Plate	Name
19335	23287	Presser Foot Shank for 19336, 20361 and 120144.....
19336	23287	Presser Foot (hinged) complete for 241-12 Machine, Nos. 7298, 19334 and 19335.....
		Note: No. 19336 is regularly furnished with 241-12 Machine.....
19441	23298	Presser Bar (hollow) for 19464.....
19442	23298	Roller Arm Bracket for 19464.....
19443	23298	Roller Arm Bracket Position Collar with 4560, for 19464.....
19444	23298	Roller Arm Bracket Spring for 24445.
19445	23298	Roller Arm Bracket Spring Pin for 24445.....
19446	23298	Roller Arm Bracket Spring Stud for 24445.....
19464	23298	Presser Bar complete, for leather work, for use with 62861, for 241-12 and 241-13 Machines, Nos. 190J, 19441 to 19443 and 24445.....
19474	24352	Feed Dog, 14 teeth (16 teeth to the inch) for use with 160331, for 160332 for 241-11 Machine.....
20123XC	23296	Throat Plate for use with 35540 for 20163, 20164, 52188 and 52189 for 241-11 Machine.....
20133	23236	Presser Foot Plate for 20134.....
20134	23236	Presser Foot (hinged) complete for 3/16 in. to 1/4 in. stitching margin, for collar and cuff work, Nos. 19223, 20133 and 26276.....
20150	24355	Presser Foot for general work and binding.....
20155	23236	Presser Foot Plate for 20157.....
20156	23236	Presser Foot Shank for 20157.....
20157	23236	Presser Foot (hinged) complete, Nos. 228J, 20155, 20156 and 62527.....
20163	23296	Feed Dog, 16 teeth (16 teeth to the inch) for 1/16 in. stitch, for use with 35540 and 160327, for 20123 and 143277.....
20164	23296	Feed Dog, 16 teeth (16 teeth to the inch) for 1/8 in. stitch, for 20123, 52190 and 143278.....
20192XC	23298	Throat Plate for use with 62861, for 12436, for 241-12 and 241-13 Machines.....
20343	23236	Presser Foot with guide on bottom to the right of needle hole.....
20356XC	23266	Throat Plate (large needle hole) for 121446.....
20357XC	-----	Throat Plate (small needle hole) for 121446, for 241-12 and 241-13 Machines.....
20360	23236	Presser Foot Plate, for 20361.....

for the library of: **Palmer Needle Corp**

NUMERICAL LIST OF PARTS

NUMERICAL LIST OF PARTS

No.	Plate	Name
20361	23276	Presser Foot (hinged) plain bottom complete, Nos. 7298, 19335 and 20360.....
20458	13215	Presser Foot for use with 44136 and 44137.....
11436	17348	Feed Lifting Rock Shaft (Front) Screw Center Oil Guard Wood Screw Washer for 150842.....
23263	12980	Tape Reel Arm Pin for 129535.....
23263	23293	Tape Reel Arm Steady Pin for 121412.....
23273	23281	Lifting Lever Spring for 143289.....
24196	23290	Machine Base and Oil Reservoir Frame - Cushion (felt) for 143306 (4).....
24445	23298	Roller Arm Bracket Spring Stud complete for 19464, Nos. 997E and 19444 to 19446.....
24726	24355	Presser Foot Plate for 24728.....
24727	24355	Presser Foot Shank for 24728.....
24728	24355	Presser Foot (hinged) with right hand Strip Guide complete, Nos. 24726, 24727 and 26276.....
25721	23226	Binder Folder for 26250.....
25722	23226	Binder Ribbon Tension for 26250.....
25878	23277	Guide.....
25888	-----	Hemmer Tongue for 160321 and 160343. Note: When ordering No. 25888, state width of hem and number of Hemmer for which required.
25983	23226	Presser Foot for 26250.....
25992	23268	Quilter Guide Holder with two 207F, for 28660.....
26026	23248	Screw Driver (large) Accessories....
26231	23286	Presser Foot Spring for 28227, 127234 and 160330.....
26250	23226	Binder (English) complete, for 1/4 in. to 9/16 in. binding, Nos. 190D, 207F, 25721, 25722, 25983, 121444, 121445XC and two 7071.....
26276	23236	Presser Foot Hinge Pin for 20134, 24728, 44161, 143168, 160324, 160340 and 160355.....
26279	23236	Presser Foot Extension 1/16 in. for use with 20157.....
26280	23236	Presser Foot Extension 1/8 in. for use with 20157.....
26281	23236	Presser Foot Extension 1/4 in. for use with 20157.....
26282	23236	Presser Foot Extension 3/8 in. for use with 20157.....
26283	23236	Presser Foot Extension 1/2 in. for use with 20157.....
26485	23248	Screw Driver (small) Accessories....

No.	Plate	Name
26603	23228	Feed Dog, 20 teeth (16 teeth to the inch) for use with 28627, 35236, 121668, 121671 and 160326, for 19336, 26603, 26605 and 120742....
26605XC	23228	Throat Plate (large needle hole) for use with 28627, 28238, 121653, 121669 and 121671 for 19336 and 26603.....
26606XC	-----	Throat Plate (small needle hole) for use with 28627, 35236, 121653, 121668, 121671 and 160326, for 19336 and 26603, for 241-12 and 241-13 Machines.....
26650	24355	Presser Foot, for braiding.....
26795	23228	Corder Cord Guide for 120207.....
26796	23228	Corder Cord Guide Arm, for 120207...
27739	23289	Thread Unwinder Thread Cone (wood) for large cones, for 225258.....
		Note: No. 27739 is used with, but not included in 225258.....
28334	23227	Binder Folder for 28776.....
28337	23227	Binder Ribbon Tension for 28776....
28622	24355	Presser Foot grooved to left of needle hole.....
28627	23255	Hemmer on Shank for 1/8 in. to 5/8 in. hem for use with 26603, 26605 and 26606.....
28628	23255	Presser Foot 3/8 in. to 5/8 in. margin for use with 28627.....
28659	23268	Quilter Guide for 28660.....
28660	23268	Quilter complete, Nos. 25992 and 28659.....
28676	23227	Presser Foot, for 28776.....
28725	24355	Presser Foot Spring Guide, for 28726
28726	24355	Presser Foot (right hand spring guide) with 665J and 28725 for 1/32 in. to 1/4 in. margins.....
		Note: When ordering Nos. 28725 or 28726, state required distance from edge of material to seam.
28775XC	23227	Throat Plate for 28776.....
28776	23227	Binder (English) complete for heavy work, Nos. 193D, 7071, 12370, 28334, 28337, 28676, 28775XC and two 233J.....
28908	24355	Presser Foot Spring Guide for 28909.
28909	24355	Presser Foot (left hand spring guide) with 665J and 28908.....
		Note: When ordering Nos. 28908 or 28909, state required distance from edge of material to seam.
28972	24352	Hemmer on Shank Holder for 160326...
32572	23277	Tension Releasing Disc for 52397....
32574	23277	Tension Releasing Pin for 52397.....

From the library of Diamond Needle Corp

NUMERICAL LIST OF PARTS

NUMERICAL LIST OF PARTS

No.	Plate	Name
35003	24356	Presser Foot Graduated Adjustable Guide (long, left) for 121949.....
35004	24356	Presser Foot Graduated Adjustable Guide (long, right) for 121949....
35005	24356	Presser Foot Graduated Adjustable Guide (short, right) for 121949...
35007	23237	Presser Foot, for use with 25236, 25238, 25241, 25241L, 25243 and 25288.....
35066	23251	Presser Foot for below 1/8 in. margin, for use with 26627.....
35125	24356	Presser Foot Graduated Adjustable Guide Clamp for 121949.....
35136	24356	Presser Foot Graduated Adjustable Guide Clamp Lever for 121949.....
35175	23300	Edge Folder on Shank for collar banding.....
35176	23300	Presser Foot for use with 35175.....
35203	23226	Blinder on Shank to turn in both edges, for bias or straight binding, for skirts, wrappers, shirt waists, etc. for 52055.....
35226	23226	Hemmer on Shank for 7/16 in. hem, for use with 26602 and 22095.....
35245	23229	Piping Attachment with 1442J for piping house dresses, for use with 44253, 44255, 44256 and 52056.....
35510	23260	Tucker Space Guide Base with 35512, 35514 and two 1426E, for 36388.....
35511	23260	Tucker Space Guide Indicator for 36388.....
35514	23260	Tucker Tuck Guide Indicator for 36394.....
35512	23260	Tucker Space Guide Pin for 35510....
35513	23260	Tucker Space Guide Stop (left) for 36388.....
35514	23260	Tucker Space Guide Stop (left) Guide Pin for 35510.....
35515	23260	Tucker Space Guide Stop (right) for 36388.....
35517	23260	Tucker Tuck Guide Arm for 36394.....
35518	23260	Tucker Tuck Guide Base for 36394....
35522	24354	Hemmer Throw-out Arm Pin for 121923 and 121925.....
35524	23260	Tucker Tuck Guide Frame Spring Washer for 36394.....
35525	23260	Tucker Tuck Guide Plate for 36394....
35529	23260	Presser Foot (wide) for 36395.....
35540	23296	Hemmer on Shank complete with right hand lower guide for lace, for use with 20123, 20163, 40318 and 143277, Nos. 1443B, 35926, 35927 and two 590D.....
35513	23176	Blinder Washer for 121737 and 121890.
35513	24318	Hemmer on Shank Holder Friction Washer for 150326.....

No.	Plate	Name
35682	23230	Hemmer (foot) for 1/8 in. hem, with guide on bottom to the right of needle hole.....
35710	23230	Hemmer (foot) for 3/32 in. hem, with guide on bottom to the right of needle hole.....
35926	23296	Hemmer for 35540.....
35927	23296	Hemmer Shank for 35540.....
35997	23230	Hemmer (foot) for 3/16 in. hem with guide on bottom to the right of needle hole.....
36069	24355	Presser Foot grooved to the left of needle hole.....
36072	23230	Hemmer (foot) for 1/4 in. hem with guide on bottom to the right of needle hole.....
36122	23230	Hemmer (foot) for 7/32 in. hem.....
36185	23300	Edge Guide Arm with 1988, for 36188.
36186	23300	Edge Guide Arm Friction Washer for 36188.....
36187	23300	Edge Guide Bed with four 465F, for 36188.....
36188	23300	Edge Guide (roller) complete, Nos. 1425D and 36185 to 36187.....
36309	23230	Hemmer (foot) for 7/32 in. hem with guide on bottom to the right of needle hole.....
36387	23260	Tucker Space Guide for 36388.....
36388	23260	Tucker Space Guide complete for 36395, Nos. 35510, 35511, 35513, 35515, 36387, 50053W and two each 1657D and 17718.....
36389	23260	Tucker Tuck Guide Bracket for 36394.
36390	23260	Tucker Tuck Guide Bracket Spring for 36394.....
36391	23260	Tucker Tuck Guide Bracket Spring Plate for 36394.....
36392	23260	Tucker Tuck Guide Frame for 36394....
36393	23260	Tucker Tuck Guide Frame Spring for 36394.....
36394	23260	Tucker Tuck Guide complete for 36395, Nos. 9D, 423AL, 803C, 1510E, 35511, 35517, 35518, 35524, 35525, 36389 to 36393, 50134E two each 1115F, 1177J, 1520J, 56814 and three wood screws 1 1/4 in. No. 10.....
36395	23260	Tucker (long arm) complete, Nos. 35528, 36388, 36394 and two 402D..
36413	23230	Hemmer (foot) plain bottom for 1/16 in. hem.....
36414	23230	Hemmer (foot) plain bottom for 3/32 in. hem.....
36416	23230	Hemmer (foot) plain bottom for 3/16 in. hem.....
36464	23236	Presser Foot Spring Guide, for 36465.

Copyright © 2011 by The Singer Co. All rights reserved.

NUMERICAL LIST OF PARTS

No.	Plate	Name
36465	23236	Presser Foot (right hand spring guide) with 665J and 36464 for 1/32 in. to 5/16 in. Stitching Margin.....
Note: When ordering Nos. 36464 or 36465, state required distance from edge of goods to seam.		
36480	23230	Hemmer (foot) plain bottom for 5/32 in. hem.....
36524	23230	Hemmer (foot) for 5/32 in. hem with guide on bottom to the right of needle hole.....
36574	23224	Presser Foot for 36575.....
36575	23224	Presser Foot 36574 with 36576 and two 50202J, for use with 44252, 44253, 44255 and 44256, for tailor work.....
36576	23224	Presser Foot Finger Guard for 36575
36637	23291	Ruffler Frame Spring Plate for 121123.....
36638	23291	Ruffler Ribbon Guide for 121123....
36641	23291	Ruffler Ruffling Blade Holder Guide for 121123.....
36642	23291	Ruffler Ruffling Blade Holder Guide Rivet for 121123.....
36644	23291	Ruffler Separating Blade for 121501
36644	23291	Ruffler Shirring Blade for 120819..
36646	23291	Ruffler Separating Blade Holder Friction Spring for 121123.....
36647	23291	Ruffler Separating Blade Holder Hinge Stud for 121123.....
36648	23291	Ruffler Separating Blade Holder Stop Stud for 121123.....
36654	23236	Presser Foot for tucking shirt bosoms.....
36696	23233	Hemmer Scroll (lower) Spring Lock Pin for 121665 and 121669.....
36696	24356	Presser Foot Graduating Adjustable Guide Clamp Steady Pin for 121948
36714	23236	Presser Foot with 233D, for 36717..
36715	23236	Presser Foot Guide (right) with 36716, for 36717.....
36716	23236	Presser Foot Guide Stud for 36715..
36717	23236	Presser Foot complete with Adjustable Guide (right), Nos. 36714 and 36715.....
36773	23236	Presser Foot for braiding.....
36819	23227	Finger Guard Friction Washer for 121327.....
36820	23227	Finger Guard Holder with 196J, for 121327.....
39026	24354	Hemmer Hinge Screw Washer for 121927.....
40264	23286	Rotating Hook Bobbin (d).....

NUMERICAL LIST OF PARTS

No.	Plate	Name
40274	23286	Rotating Hook Section for 143342 and 143343.....
40282	23290	Machine Base and Oil Reservoir Frame Bolt Nut Washer for 143307 (4).....
40315	23236	Presser Foot, for long stitch, for general work.....
40316	23296	Presser Foot Plate for 40318.....
40317	23296	Presser Foot Shank for 40318.....
40318	23296	Presser Foot (hinged) complete, for lace running, for 35540, Nos. 40316, 40317 and 62527.....
40322	23236	Presser Foot (narrow).....
40392	23286	Rotating Hook Bobbin Case Latch for 40393.....
40393	23286	Rotating Hook Bobbin Case Hinge, for 52237, Nos. 2974, 40392 and 125320.....
40394	23286	Rotating Hook Bobbin Case Tension Spring for 52236.....
41564	23248	Machine Rest Pin (wood) (Accessories).....
42290	22920	Tape Reel Pin Washer for 120740..
43525	23293	Binder Steady Pin for 121398 and 121870.....
43525	22920	Throat Plate Stud for 120741.....
43944	23277	Tension Releasing Lever for 241-11 and 241-12 Machines.....
44136	23225	Feed Dog, 15 teeth (16 teeth to the inch), for use with 12142, 20458 and 44137.....
44137XC	23225	Throat Plate for use with 12142, 20458 and 44136.....
44158	23266	Feed Dog, 15 teeth (14 teeth to the inch) for 44162.....
44159	23266	Presser Foot Plate for 44161.....
44160	23266	Presser Foot Shank for 44161.....
44161	23266	Presser Foot (hinged) complete for use with 44158 and 44162, Nos. 26276, 44159 and 44160.....
44162XC	23266	Throat Plate for 44158 and 44161....
44252	23224	Feed Dog 12 teeth (12 teeth to the inch) for 44255 and 44256, for tailor work.....
44253	23224	Feed Dog, 16 teeth (16 teeth to the inch), for use with 35245, for 44255 and 44256.....
44255XC	-----	Throat Plate (small needle hole) for use with 35245 and 36575, for 44252 and 44253, for 241-12 and 241-13 Machines.....
*44256XC	23224	Throat Plate (large needle hole) for use with 35245 and 36575, for 44252 and 44253.....

NUMERICAL LIST OF PARTS

NUMERICAL LIST OF PARTS

No.	Plate	Name
50135W	23277	Tucker Splice Guide Thumb Screw for 36298.....
50117J	23277	Face Plate Thread Guard (lower) Screw for 143231.....
50117J	23277	Face Plate Thread Guard (upper) Screw for 143231.....
50117AL	23277	Feed Dog Screw (2).....
50107E	23272	Oil Pump (centrifugal) Impeller Locking Screw.....
50134E	23260	Tucker Tuck Guide Base Screw Stud for 36394.....
50190J	23277	Guide Thumb Screw.....
50191C	23281	Feed Lifting Rock Shaft Screw Center for 52097 (2).....
50191C	23281	Feed Rock Shaft Screw Center (left) for 52097.....
50202J	23224	Presser Foot Finger Guard Screw for 36575 (2).....
50207F	23292	Ruffler Needle Clamp Screw for 120448.....
50217J	23212	Oil Flow Window Cap Screw (4).....
50305J	23227	Finger Guard Holder Set Screw for 120858.....
50304C	23277	Tension Stud for 52098.....
50305C	23277	Tension Stud Set Screw for 52083.....
50316J	23227	Finger Guard Screw for 121327.....
50429AL	23281	Rotating Hook Shaft Oil Sling Set Screw, for 143133 (2).....
50519J	23281	Feed Lifting Rock Shaft Crank Slide Block Oil Wick Holder Screw for 143041.....
50617R	23272	Stitch Regulator Plunger Hole Plug Screw.....
50741E	23283	Machine and Machine Base and Oil Reservoir Screw (for shipping purposes only).....
51088R	23290	Machine Base and Oil Reservoir Frame Bolt with 51581R, for 143307 (4).....
51097J	23293	Binder Thumb Screw for 121168 and 121871.....
51097J	22920	Binder (transverse) on Shank Thumb Screw for 120742.....
51097J	23293	Tape Reel Arm Thumb Screw for 120742, 121168 and 121871.....
51219F	23291	Ruffler Driving Lever Hinge Screw for 121123.....
51220AL	23281	Feed Bar Adjusting Screw, for 143185 (2).....
51221F	23291	Ruffler Ruffling Blade Holder Hinge Screw for 121123.....
51224W	24352	Hemmer on Shank Thumb Screw for 160326.....
51272C	23291	Ruffler Roller Stud and Needle Clamping Screw for 121451.....

No.	Plate	Name
51283AL	23275	Balance Wheel Set Screw for 143363 (2).....
51369R	23275	Arm Top Cover Screw (2).....
51359E	23212	Oil Lead Screw.....
51371K	23291	Ruffler Driving Lever Adjusting Thumb Screw (lower) for 121121....
51581R	23290	Machine Base and Oil Reservoir Frame Bolt Nut for 51088R (4)....
51649J	23284	Knee Lifter Rock Shaft Crank Adjusting Screw Lock Nut for 143282.....
51701C	23281	Rotating Hook Oil Flow Regulating Screw Body Lock Nut for 143183....
51901	23298	Roller, 7/8 in. diam, 1/8 in. face (fine) ball bearing complete for 62861, Nos. 1528J, 201699F, 350104F and twenty-eight 206417..
52016	23286	Presser Bar Lifter for 241-11 and 241-12 Machines.....
52018	23281	Rotating Hook Bobbin Case Holder Position Bracket.....
52023	23286	Thread Take-up Lever Hinge Stud for 143099.....
52031	24354	Feed Dog, 19 teeth (22 teeth to the inch) for use with 121927, 160319 and 160321, for 52032, 52033, 121798, 121801 to 121804 and 121848, for 241-11 and 241-12 Machines.....
52032XC	-----	Throat Plate (large needle hole) for 52031, 121798, 121801 to 121804 and 121848.....
52033XC	23277	Throat Plate (small needle hole) for use with 121927, 160319 and 160321, for 52031, for 241-11 Machines.....
		Note: No. 52033 is sent with 241-11 Machine unless otherwise specified on order.
52055	23228	Presser Foot for 35208.....
52056	23292	Presser Foot for 35245.....
52083	23277	Thread Take-up Spring Regulator with 50305C for 52397.....
52097	-----	Feed Lifting Rock Shaft Screw Center 50191C with 1513J (2).....
52097	-----	Feed Rock Shaft Screw Center (left) 50191C with 1513J.....
52098	-----	Tension Stud 50304C with 1560C for 52397.....
52130	23286	Thread Take-up Lever Thread Eyelet Bushing for 143152 and 143153....
52171	23286	Needle Bar Bushing (lower) Thread Eyelet.....
52188	23297	Presser Foot (solid) for cuff work for 20123 and 52190.....

NUMERICAL LIST OF PARTS

NUMERICAL LIST OF PARTS

No.	Plate	Name
52192	23296	Presser Foot (solid) for collar work, for 20123 and 52190.....
52193	23296	Throat Plate, for 20164, 52188 and 52189, for 241-11 Machine.....
52235	23286	Rotating Hoop & Bobbin Case, for 52236.....
52236	-----	Rotating Hook Bobbin Case 52235 with 501F, 1580E and 40394, for 52237.
52237	23286	Rotating Hook Bobbin Case complete, for 143344 and 143345, Nos. 592E, 2875, 40393 and 52236.....
52238	23277	Arm Crank Pin and Thread Eyelet.....
52239	23281	Feed Lifting Rock Shaft Crank Slide Block with Stud for 143041.....
52240	23288	Presser Foot Shank, for 127234.....
52294	23277	Thread Take-up Spring for 52397.....
52337	23277	Tension complete, Nos. 2103, 32572, 32574, 52083, 52098, 52394 and two 2102.....
52445	23279	Tension Releasing Lever for 241-13 Machine.....
52454	23277	Thread Retainer.....
52462	23286	Feed Dog, 19 teeth (22 teeth to the inch) for 12463 and 143243.....
52463XC	23286	Throat Plate for 52462.....
52544	23283	Presser Foot Spring for 143168.....
52813	-----	Feed Bar Screw Center 2130 with 1519J (2).....
52814	-----	Tucker Tuck Guide Bracket Screw Center 3070 with 1513J for 36394 (2).....
62127	23286	Presser Foot Hinge Pin for 20157, 4031b, 62927, 121946, 127234 and 160730.....
62412	23286	Face Plate Thread Lubricator Oil Pad (felt) for 143354.....
62827	23280	Face Plate Thread Lubricator Wick for 143354.....
62855	23298	Roller Arm for 62861.....
62861	23298	Roller Presser (ball bearing) complete, 7/8 in. fine roller with roller set 1/8 in. beyond center of needle, for leather work, for use with 19464, for 241-12 and 241-13 Machines, Nos. 51901 and 62855.....
62925	23286	Presser Foot Plate for 62927.....
62926	23286	Presser Foot Shank for 62927.....
62927	23286	Presser Foot (spring hinged) complete, for 241-11 Machine and for use with 12481 and 12482 (Boston), Nos. 26231, 62527, 62925 and 62926.....

Note: 62927 is regularly furnished with 241-11 Machine.

No.	Plate	Name
64519	23275	Arm Top Cover Stitch Regulator Plunger Spring for 143204 and 143206.....
120143	23282	Presser Foot Plate for 120144.....
120144	23282	Presser Foot (hinged) complete for button stays, for 121653, Nos. 7298, 19335 and 120143.....
120206	23228	Corder Cord Guide Bed with 457AL, for 120207.....
120207	23228	Corder Adjustable complete, for short turns or cushions, Nos. 190J, 1044D, 26795, 26796 and 120206.....
120208	23228	Presser Foot (grooved) for use with 120207.....
120367	23255	Hemmer on Shank, for handkerchief work.....
120427	24352	Hemmer on Shank Holder Shank for 160326.....
120479	23268	Quilter Guide (left) for 120485.....
120480	23268	Quilter Guide (right) for 120485.....
120481	23268	Quilter Guide Bracket for 120482.....
120482	-----	Quilter Guide Bracket 120481 with 120483 and two 209C, for 120485.....
120483	23268	Quilter Guide Disengaging Sleeve for 120482.....
120484	23268	Quilter Guide Disengaging Sleeve Spring for 120485.....
120485	23268	Quilter complete, Nos. 602D, 120479, 120480, 120482 and 120484.....
120532	22920	Binder (transverse) on Shank for 120742.....
120535	22920	Tape Reel Arm with 23263 and 120536 for 120742.....
120536	23293	Tape Reel Disc with 120538 and 120539, for 120742, 121168, 121737, 121871 and 121890.....
120537	23293	Tape Reel Disc Pin for 120535 and 121412.....
120538	23293	Tape Reel Disc Stud (wood) for 120536.....
120539	23293	Tape Reel Disc Stud Sleeve (brass) for 120536.....
120737	22920	Piping Attachment with 217J for 120742.....
120738	22920	Presser Foot for 120742.....
120739	22920	Tape Guide for 120742.....
120740	23276	Tape Reel Pin 120775 with 42290, for 120742, 121737 and 121890.....
120741XC	22920	Throat Plate with 43525, for 120742

Note: When ordering No. 120207, state size or number of cords to the inch.

From the library of: Diantond Needle Corp.

NUMERICAL LIST OF PARTS

NUMERICAL LIST OF PARTS

73

No.	Plate	Name	No.	Plate	Name
120741	12260	Binding and Piping Attachment complete, Nos. 3146, 26603, 120532, 120535, 120737 to 120740, 120741XC and two each 190J, 7071, 51097J and 120536.....	121121	23291	Ruffler Ruffling Blade Lever with 560B and 51371K, for 121123.....
120775	21920	Tape Reel Pin for 120740.....	121123	23291	Ruffler complete for 121451 and 160449, Nos. 240B, 1700J, 1772J, 36637, 36638, 36641, 36642, 36646 to 36648, 51219F, 51221F, 120812, 120813, 121116, 121117, 121120, 121121 and 121501.....
120807	23230	Hemmer (foot) for 1/8 in. hem.....	121167	23293	Binder Folder on Shank for 121168 and 121871.....
120804	23230	Hemmer (foot) for 5/32 in. hem.....	121168	23293	Binder (transverse) on Shank complete, for 241-12 and 241-13 Machines, for folded on unfolded bias binding, with tape reel, for general work, for 3/4 in., 7/8 in. and 1 in. tape, Nos. 3146, 120536, 121167, 121169, 121397, 121398XC, 121412 and two 51097J.....
120806	23230	Hemmer (foot) for 3/16 in. hem.....	121169	23293	Presser Foot for 121168, 121737, 121871 and 121890.....
120808	23230	Hemmer (foot) for 1/4 in. hem.....	121326	23227	Finger Guard for 121327.....
120907	23230	Hemmer (foot) for 5/16 in. hem.....	121327	23227	Finger Guard (metal) complete, Nos. 36819, 36820, 50316J and 121576.....
120812	23291	Ruffler Driving Lever Bushing for 121123.....	121597	23293	Feed Dog, 18 teeth (16 teeth to the inch) for 121168 and 121871.....
120813	23291	Ruffler Driving Lever Friction Washer for 121123.....	121398XC	23293	Throat Plate with 43525 for 121168.....
120818	23291	Ruffler Shirring Blade Holder for 120819.....	121412	23293	Tape Reel Arm with 8879, 23263 and 120537, for 121168 and 121871.....
120819	23291	Ruffler Shirring Blade Holder 120818 with 36644 and two 120829, for 121491 and 160449.....	121444	23226	Feed Dog, 13 teeth (16 teeth to the inch) for 26250.....
120828	23136	Presser Foot (single toe) for gathering, for fine work.....	121445XC	23226	Throat Plate for 26250.....
120829	23291	Ruffler Ruffling Blade Rivet for 121123 (2).....	121446	23228	Feed Dog, spiked teeth, 13 teeth (10 teeth to the inch) for use with Corder No. 120207, for 20356, 20357 and 121447.....
120833	23291	Ruffler Separating Blade Rivet for 121501 (2).....	121447XC	23228	Throat Plate for use with Corder No. 20207 for 121446.....
120829	23291	Ruffler Shirring Blade Rivet for 120809 (2).....	121451	23291	Ruffler 121123 with 1981, 51272C and 120819 for 241-11 Machine....
120830	23291	Ruffler Separating Blade Holder for 121501.....	121501	-----	Ruffler Separating Blade Holder 120830 with 36644 and two 120829, for 121123.....
120837	23230	Hemmer (foot) plain bottom, for 1/8 in. hem, slotted for lace.....	121507	23227	Finger Guard for 121562.....
120858	23227	Finger Guard Holder with 56302J, for 121562.....	121562	23227	Finger Guard (wire) complete, Nos. 120858, 121507, and two 236J.....
120938	23230	Hemmer (foot), for 1/16 in. to 1/8 in. hem, for China Silk, etc....	121646	23297	Feed Dog, 12 teeth (16 teeth to the inch) for 121649, for 241-11 Machine.....
120911	23230	Hemmer (foot with Shell hemmer), for 5/32 in. to 1/4 in. hem, for China Silk, etc.....	121647	23297	Presser Foot with 121648 and two 337J, for 3/16 in., 7/32 in., 1/4 in., 9/32 in. and 5/16 in. Stitching Margin, for collar work (second stitching), for 241-11 Machine.....
120938	23230	Hemmer (foot), for 3/32 in. hem....			
120939	-----	Hemmer Tongue for 160318, 160331 and 160344.....			
		Note: When ordering No. 120939, state width of hem and number of Hemmer for which required.			
120991	23255	Hemmer on Shank, for 1/16 in. to 1/4 in. hem.....			
121116	23291	Ruffler Driving Lever for 121123...			
121117	23291	Ruffler Frame for 121123.....			
121118	23291	Ruffler Ruffling Blade for 121120 .			
121119	23291	Ruffler Ruffling Blade Holder for 121120.....			
121120	-----	Ruffler Ruffling Blade Holder 121119 with 121118 and two 120829 for 121123.....			

NUMERICAL LIST OF PARTS

NUMERICAL LIST OF PARTS

No.	Plate	Name
121647	23297	Presser Foot Edge Guide for 3/16 in., 7/32 in., 1/4 in., 9/32 in. and 5/16 in. Stitching Margin, for 121647.....
121648XC	23297	Throat Plate, for 121646, for collar work (second stitching) for 241-11 Machine.....
121653	23298	Hammer on Shank for 9/16 in. hem, for button stays for use with 120144.....
121655	23295	Binder on Shank, for sleeve plackets (facing).....
121656	23295	Presser Foot for use with 121655, for sleeve plackets (facing).....
121658	23296	Edge Folder with Edge Guide on Shank for use with 121660, for yoking.....
121659	23296	Presser Foot Plate for 121660.....
121659	23296	Presser Foot (hinged) complete, for use with 121658 for yoking Nos. 7298, 19223 and 121659.....
121662	23294	Joining Attachment for use with 121662, for shoulder joinings....
121663	23294	Presser Foot for use with 121662, for shoulder joinings.....
121665	23233	Hemmer Scroll (lower) on Shank with 337B, 36696 and 121667, for 121668.....
121668	23233	Hemmer Scroll (upper) for 121668...
121667	23233	Hemmer Scroll (lower) Spring for 121665 and 121669.....
121668	23233	Hemmer on Shank complete for use with 35063 for 7/8 in. to 2 in. hem, for hemming pillow cases, Nos. 121665 and 121666.....
121669	23233	Hemmer Scroll (lower) on Shank with 337B, 36696 and 121667, for 121671.....
121670	23233	Hemmer Scroll (upper) for 121671...
121671	23273	Hemmer on Shank complete for use with 35063, for 2 1/16 in. to 4 in. hem, for hemming pillow cases Nos. 121669 and 121670.....
121672	24354	Hemmer on Shank for 121924.....
121675	24354	Hemmer on Shank for 121926.....
121678	24354	Hemmer Tension spring for 121927...
121680	24354	Presser Foot for use with 121927...
121732	23276	Binder (transverse) for 121737 and 121890.....
121733	23276	Binder Throw-out Arm with 192349, for 121737 and 121890.....
121734	23276	Binder Throw-out Arm Bracket Rivet for 121889 and 121939 (2).....
121735	13276	Binder Releasing Lever for 121737 and 121890.....

No.	Plate	Name
121736	23276	Binder Releasing Lever Spring for 121737 and 121890.....
121737	23276	Binder (transverse) with Throw-out Arm complete, for 241-12 and 241-13 Machines, for folded or unfolded bias binding, with tape reel, for general work, for 3/4 in., 7/8 in. and 1 in. tape, Nos. 724F, 940F, 35610, 120536, 120740, 121169, 121732, 121733, 121735, 121736, 121739, 121938XC and two 1443J.....
121738	23276	Feed Dog, 17 teeth (16 teeth to the inch) for 121737 and 121890.....
121741	23248	Oil quart can filled with light grade stainless oil (Accessories)
121758	23230	Feed Dog, 13 teeth (16 teeth to the inch) for use with 121760, for 121759.....
121759XC	23230	Throat Plate (small needle hole) for use with 121760, for 121758
121760	23230	Hemmer (foot) for hemming shirts, for 1/8 in. hem for 121758 and 121759.....
121761	23230	Hemmer (foot) with 121981, for hemming shirts, for 1/8 in. hem
121762	23230	Hemmer (foot) with 121981, for 5/32 in. hem.....
121763	23236	Presser Foot with hemmer with Yielding Top Scroll, for margins up to 9/32 in.....
121798	23255	Hemmer (foot) with 121981, for 1/8 in. hem, for hemming shirts, for use with 52031 and 52032.....
121801	23255	Hemmer (foot) with 121981, for 1/8 in. hem, for hemming shirts, for use with 52031 and 52032.....
121802	23255	Hemmer (foot) with 121981, for 5/32 in. hem, for hemming shirts, for use with 52031 and 52032.....
121803	23255	Hemmer (foot) with 121982 (wide folder) for 3/16 in. hem, for hemming shirts, for use with 52031 and 52032.....
121804	23255	Hemmer (foot) with 121982 (narrow folder) for 3/16 in. hem, for hemming shirts, for use with 52031 and 52032.....
121841	23257	Hemmer on Shank for 3/4 in. to 1 in. hem, for hemming sheets.....
121842	23257	Hemmer on Shank for 2 1/4 in. to 3 in. hem, for hemming sheets....
121845	23257	Needle Threader complete, Nos. 140157J and three 121846.....
121846	23257	Needle Threader Hook for 121845 (3)

From the Library of: Diamond Needle Corp.

NUMERICAL LIST OF PARTS

NUMERICAL LIST OF PARTS

121944

No.	Plate	Name
121944	24356	Hammer (No. 1) with 121923, for 3/4 in. hem, for hemming shirts, for use with 52003 and 52002.....
121944	24356	Throat Plate with 44421, for 121971
121944	24356	Slider (transverse) on Shank complete for 241-11 Machine, for folded or unfolded bias bindings, with tape reel, for general work for 3/4 in., 7/8 in. and 1 in. tape, Nos. 2146, 22036, 221167, 221169, 221397, 221410, 221873C and two 21097J.....
121944	24356	Hammer on Shank for 3 1/4 in. to 4 in. hem, for hemming sheets.....
121944	24356	Throat Plate with two 121724, for 11 in.
121944	24356	Slider (transverse) with Throw-out Arm complete for 241-11 Machine, for folded or unfolded bias binding, with tape reel, for general work, for 3/4 in., 7/8 in. and 1 in. tape, Nos. 724F, 940F, 35610, 35628, 221743, 221750, 221752, 221753, 221755, 221756, 221758, 22190XC and two 1443J.....
121944	24356	Hammer Throw-out Arm with 35522, for 121924.....
121944	24356	Hammer complete on Throw-out Arm for 1 in. hem, for hemming sheets, for 121927, Nos. 121672, 121922 and two 1499J.....
		Note: When ordering 121924, state width of hem.
121944	24356	Hammer Throw-out Arm with 35522, for 121926.....
121944	24356	Hammer complete on Throw-out Arm for 1 in. or 3 in. hem, for hemming sheets for 121927, Nos. 121678, 121921 and two 1499J.....
121944	24356	Hammer complete for 1 in., 2 in. and 3 in. hem, for hemming sheets, for use with 121680, Nos. 24J, 39422, 121673, 121924 and 121926..
		Note: When ordering No. 121927, state width of hem.
121944	24356	Throat Plate with two 121734, for 121737.....
121944	24356	Presser Foot for No. 3 Slide Fastener, for stitching either at the right or left of the Slide Fastener.....
121944	24356	Presser Foot for No. 3 and No. 5 Slide Fastener, for stitching at the right of the Slide Fastener....

No.	Plate	Name
121941	24356	Presser Foot, for No. 5 Slide Fastener, for stitching at the right or left of the Slide Fastener, for heavy woolen suiting and dresses.....
121942	24356	Presser Foot, for No. 3 and No. 5 Slide Fastener, for stitching at the left of the Slide Fastener....
121943	24356	Presser Foot Plate for 121946.....
121944	24356	Presser Foot Shank for 121946.....
121945	-----	Presser Foot Spring for 121946.....
121946	24356	Presser Foot complete for No. 5 Slide Fastener, for stitching at the right or left of the Slide Fastener, for crossing seams, Nos. 62527 and 121943 to 121945.....
121947	24356	Presser Foot for No. 3 and No. 5 Slide Fastener, for stitching at the Slide Fastener, for handbags, pocketbooks, etc.....
121948	24356	Presser Foot with 36696, for 121949
121949	24356	Presser Foot with Graduated Adjustable Guide complete for No. 3 and No. 5 Slide Fastener, for making various margins up to 1/2 in. between the Slide Fastener and the line of stitching, Nos. 337B, 35003 to 35005, 35135, 35136 and 121948.....
121950	24356	Presser Foot with toes turned up close to needle hole for No. 3 Slide Fastener.....
121951	24356	Presser Foot for No. 3 and No. 5 Slide Fastener, for stitching material with a heavy nap.....
121952	24356	Presser Foot for No. 5 Slide Fastener, for stitching woolen suiting material.....
121980	24353	Hammer on Shank for 1 1/4 in. to 2 in. hem, for hemming sheets.....
121981	-----	Hammer Tongue for 121761, 121762, 121798, 121801, 121802 and 160316
121982	-----	Hammer Tongue for 121803 and 121804
121983	-----	Hammer Tongue for 121848.....
		Note: When ordering Nos. 121981 to 121983, state width of hem and number of Hammer for which required.
124371	23280	Face Plate Thread Lubricator Oil Reservoir Rivet Washer (outside) for 143356.....
125320	23286	Rotating Hook Bobbin Case Latch Lever for 40393.....
127233	23288	Presser Foot Plate for 127234.....

From the library of Hammond Sewing Corp

NUMERICAL LIST OF PARTS

No.	Plate	Name
127234	23289	Presser Foot (spring hinged) complete, for 241-13 Machine, Nos. 26231, 52390, 62527 and 127233.....
127257	23285	Presser Foot Plate for 127260.....
127258	23285	Presser Foot Shank with 665J for 127260.....
127259	23285	Presser Foot Thread Cutter for 127260.....
127260	23285	Presser Foot (hinged) complete with Thread Cutter, Nos. 239E, 127257 to 127259 and 131256.....
127319	23278	Feed Dog, 19 teeth (16 teeth to the inch) for 127320 and 127321, for 241-12 and 241-13 Machines.....
		Note: No. 127319 is regularly furnished with 241-12 Machine.
127320XC	23278	Throat Plate (large needle hole) for 127319, for 241-12 and 241-13 Machines.....
		Note: No. 127320 is regularly furnished with 241-12 Machine.
127321XC	-----	Throat Plate (small needle hole) for 127319, for 241-12 and 241-13 Machines.....
129090	23248	Wrench for 51701 (not regularly furnished).....
131256	23285	Presser Foot Hinge Pin for 127260..
135167	23290	Tucker Base Block (wood) 6 in. diam. 1 1/2 in. thick for 143307.....
139619	24355	Presser Foot with 228J (needle hole on left hand side) for use with 139619.....
139619	24355	Presser Foot Strip Gauge for use with 139618.....
139628	24355	Presser Foot for 139630.....
139629	24355	Presser Foot Spring Guide for 139630.....
139630	24355	Presser Foot complete with Spring Guide at right side of needle, for 1/32 in. to 1/2 in. margins, Nos. 665J, 139628 and 139629.....
		Note: When ordering Nos. 139628 to 139630, state required distance from edge of material to seam.
140050J	23277	Face Plate screw (upper).....
140050J	23280	Face Plate Lubricator Screw for 143357.....
140061J	23277	Face Plate Screw (lower).....
140119AL	23287	Needle Clamp Screw for 143328.....
143157J	23257	Needle Threader Hook Screw for 121845.....
140230C	23272	Feed Lifting Rock Shaft Connecting Rod Hinge Screw.....

NUMERICAL LIST OF PARTS

No.	Plate	Name
140230C	23272	Feed Rock Shaft Connecting Rod Hinge Screw.....
140231C	23286	Needle Bar Connecting Link Cap Screw for 143330 and 143332.....
140232J	23272	Oil Wick Holder Screw.....
140239AL	23286	Needle Set Screw for 143335.....
140256AL	23272	Feed Eccentric Stop Screw (7 stitch).....
		Note: No. 140256AL is regularly furnished with 241-11 Machine.
140257AL	23272	Feed Eccentric Stop Screw (5 1/2 stitch).....
		Note: No. 140257AL is regularly furnished with 241-12 and 241-13 Machines.
140258AL	23272	Feed Eccentric Stop Screw (14 stitch).....
140259C	23281	Rotating Hook Shaft Bushing (back) Set Screw.....
140278C	23281	Feed Rock Shaft Screw Center (right) for 143138.....
140296AL	23272	Arm Shaft (horizontal) Bushing (center) Set Screw.....
140297AL	23272	Arm Shaft (horizontal) flanged Bushing (back) Set Screw.....
140298AL	23272	Arm Shaft (upright) Bushing (lower) Set Screw.....
140298AL	23272	Arm Shaft (upright) Bushing (upper) Set Screw.....
140315E	23272	Arm Screw Stud (back) (2).....
140316C	23281	Rotating Hook Oil Flow Regulating Screw for 143183.....
140317J	23275	Arm Top Cover Stitch Regulator Plunger Hole Plug Screw, for plugging the Plunger hole when Plunger is removed to prevent tampering with the stitch set (for Agents only).....
140327AL	23272	Thread Take-up Crank Clamping Screw for 143237 and 143239.....
140331AL	23272	Arm Shaft (horizontal) flanged Bushing (front) Set Screw.....
140343E	23283	Machine and Machine Base and Oil Reservoir Screw Hole Plug Screw..
140346AL	23275	Balance Wheel Set Screw for 143265 (2).....
140350AL	23284	Knee Lifter Rock Shaft Crank Adjusting Screw for 143282.....
140351AL	23284	Knee Lifter Rock Shaft Crank Clamping Screw for 143281.....
140351AL	23284	Knee Lifter Rock Shaft Knee Arm Hub Clamping Screw for 143284.....
140351AL	23284	Knee Lifter Rock Shaft Stop Dog Clamping Screw for 143287.....
140359E	23272	Arm Shaft (horizontal) Screw Plug (front) for 143233 and 143235....
140380E	23272	Stitch Regulator Locking Slide Spring Screw for 143134.....

NUMERICAL LIST OF PARTS

No.	Plate	Name
14300AL	23286	Presser Foot Screw.....
140411D	23272	Arm Shaft (horizontal) Screw (back)
142057	24353	Feed Dog, 21 teeth (22 teeth to the inch) for 142060 and 142061.....
142060XC	-----	Throat Plate (small needle hole), for 142057, for Chaining-off, for 241-11 Machine.....
142061XC	24353	Throat Plate (large needle hole), for 142057 and 142062, for Chaining-off.....
142062	24353	Feed Dog, 17 teeth (18 teeth to the inch) for 142060 and 142061.....
143002	23272	Arm Hole Plug (top of arm), for plugging hole used to assemble take-up oil wicks.....
143003	23 72	Arm Shaft (horizontal) for 143232 to 143235.....
143008	23272	Arm Shaft (horizontal) Bushing (center).....
143009	23272	Arm Shaft (horizontal) Flanged Bushing (front).....
143013	23272	Arm Shaft (upright).....
143014	23272	Arm Shaft (upright) Bevel Gear (lower) right hand spiral with two 1259AL, for 143295.....
143015	23272	Arm Shaft (upright) Bevel Gear (upper) left hand spiral with two 1259AL, for 143294.....
Note: When ordering Nos. 143014 or 143015 Class No. of Machine must be stated.		
143016	23272	Arm Shaft (upright) Bushing (lower)
143017	23272	Arm Shaft (upright) Bushing (upper)
143018	23272	Arm Side Shield.....
143020	23275	Arm Top Cover Gasket (cork).....
143024	23272	Bed Hole Plug.....
143030	23281	Feed Bar.....
Note: No. 143030 is regularly furnished with these Machines.		
143031	23281	Feed Bar Screw Center Oil Wick for 143033.....
143032	23281	Feed Bar Screw Center Oil Wick Holder for 143033.....
143033	23281	Feed Bar Screw Center Oil Wick Holder 143032 with 143031.....
143034	-----	Feed Eccentric for 143123.....
143035	-----	Feed Eccentric Body with 1375AL and two 1036AL, for 143123.....
143036	23272	Feed Lifting Eccentric and Arm Shaft (horizontal) Bevel Gear, right hand spiral with 1036AL, 1375AL and 143088, for 143294.....
143039	23281	Feed Lifting Rock Shaft Cap.....
143040	23272	Feed Lifting Rock Shaft Connecting Rod for 143292.....
143041	23281	Feed Lifting Rock Shaft Crank with 157J, 50579J, 52267 and 143044 for 143270.....

NUMERICAL LIST OF PARTS

No.	Plate	Name
143042	23281	Feed Lifting Rock Shaft Crank Slide Block Oil Wick for 143044.....
143042	23281	Rotating Hook Shaft Oil Filter Wick for 143350.....
143043	23281	Feed Lifting Rock Shaft Crank Slide Block Oil Wick Holder for 143044.....
143044	23281	Feed Lifting Rock Shaft Crank Slide Block Oil Wick Holder 143043 with 143042, for 143041.....
143045	23281	Feed Lifting Rock Shaft Screw Center Front Oil Wick for 143053 and 143271.....
143046	23281	Feed Rock Shaft for 143047.....
143047	-----	Feed Rock Shaft complete for 143221 Nos. 143046 and 143050.....
143048	23281	Feed Rock Shaft Cap.....
143049	23272	Feed Rock Shaft Connecting Rod for 143292.....
143050	23281	Feed Rock Shaft Crank with 157J, for 143047.....
143051	23281	Feed Rock Shaft Screw Center Front Oil Wick for 143053 and 143221.....
143052	23281	Feed Rock Shaft Screw Center Front Oil Wick Holder for 143053.....
143053	23281	Feed Rock Shaft Screw Center Front Oil Wick Holder 143052 with 143045 and 143051.....
143054	23286	Needle Bar Connecting Link for 143325.....
143056	23286	Needle Bar Connecting Link Roller Bearing for 143330 and 143332 (18).....
143056	23286	Thread Take-up Lever Roller Bearing for 143152, 143153, 143329 and 143331.....
143058	23286	Needle Bar Connecting Stud Slide Block for 143330 and 143332.....
143060	23212	Oil Flow Body.....
143061	23212	Oil Flow Body Gasket (2).....
143062	23212	Oil Flow Window.....
143063	23212	Oil Flow Window Cap.....
143064	23212	Oil Pipe for 143067.....
143065	23212	Oil Pipe Clamping Sleeve for 143067 (2).....
143066	23212	Oil Pipe Clamping Sleeve Nut for 143067 (2).....
143067	23212	Oil Pipe complete from Oil Pump to Arm Shaft (horizontal) Center Bearing, Nos. 143064 and two each 143065 and 143066, (for Agents only).....
143068	23212	Oil Pipe with 143124 for oiling Rotating Hook Shaft Front Bearing (for Agents only).....

NUMERICAL LIST OF PARTS

NUMERICAL LIST OF PARTS

No.	Plate	Name
143070	23212	Oil Pump (centrifugal) Body with 143126.....
143071	23212	Oil Pump (centrifugal) Body Position Pin (2).....
143072	23212	Oil Pump (centrifugal) Cover.....
143073	23212	Oil Pump (centrifugal) Impeller....
143074	23212	Oil Pump (centrifugal) Screen.....
143075	23212	Oil Pump (centrifugal) Screen Frame
143077	23272	Oil Wick Holder complete for 241-11 Machine, Nos. 143197 and 143200..
143079	23286	Presser Bar Lifter Hinge Stud.....
143081	23281	Rotating Hook Shaft Bevel Gear (left hand spiral) with two 1259AL, for 143295.....
143082	23281	Rotating Hook Shaft Bushing (back)..
143083	23281	Rotating Hook Shaft Bushing (front)
143085	23272	Stitch Regulator for 143134.....
143086	23272	Stitch Regulator Locking Slide for 143134.....
143087	23272	Stitch Regulator Locking Slide Ratchet Wheel for 143294.....
143088	-----	Stitch Regulator Locking Slide Ratchet Wheel Pin for 143036.....
143089	23272	Stitch Regulator Locking Slide Spring for 143134.....
143096	23286	Thread Take-up Lever Link for 143099.....
143097	23286	Thread Take-up Lever Link Hinge Stud for 143329 and 143331.....
143098	23286	Thread Take-up Lever Roller Bearing Retaining Washer for 143152, 143153, 143329 and 143331.....
143099	-----	Thread Take-up Lever complete, for 143329 and 143331, Nos. 52023 and 143096.....
143102	23281	Bell Crank for 143105.....
143103	23281	Bell Crank Bracket for 143105.....
143104	23281	Bell Crank Hinge Pin for 143105....
143105	-----	Bell Crank complete for 143289, Nos. 143102 to 143104.....
143108	23281	Lifting Lever Connecting Rod for 143289.....
143109	23281	Lifting Lever Connecting Rod Swivel for 143289.....
143116	23212	Oil Lead.....
143117	23272	Arm Shaft (horizontal) Flanged Bushing (back).....
143123	23272	Feed Eccentric 143034 with 143035, for 143292.....
143124	23212	Oil Pipe Clamping Sleeve for 143068
143125	23212	Oil Pipe Clamping Sleeve Nut.....
143126	23212	Oil Pipe Clamping Sleeve Nut Adaptor for 143070.....
143127	23286	Presser Bar Spring.....

No.	Plate	Name
143133	23281	Rotating Hook Shaft Oil Sling with two 50429AL for 143348.....
143134	-----	Stitch Regulator 143085 with 140380E, 143086 and 143089 for 143292.....
143135	23277	Thread Guard (side of arm).....
143138	-----	Feed Rock Shaft Screw Center (right) 140278C with 1513J.....
143147	23274	Oil Wick Holder complete for 241-13 Machine, Nos. 143197 and 143200..
143151	23273	Oil Wick Holder complete for 241-12 Machine, Nos. 143197 and 143200..
143152	-----	Thread Take-up Lever with 52130, 143098 and eighteen 143056, for 241-11 and 241-12 Machines (for Agents only).....
143153	-----	Thread Take-up Lever with 52130, 143098 and eighteen 143056, for 241-13 Machine (for Agents only).....
143165	23263	Feed Dog, 18 teeth (14 teeth to the inch) for 143169, for curtain work.....
143166	23263	Presser Foot Plate for 143168.....
143167	23263	Presser Foot Shank 143168.....
143168	23263	Presser Foot (spring hinged) com- plete, for use with 143165 and 143169 for curtain work, Nos. 26276, 52544, 143166 and 143167..
143169XC	23263	Throat Plate (large needle hole) for 143165 for curtain work.....
143170	23266	Feed Dog, 16 teeth (16 teeth to the inch) for 143171 and 143222.....
143171XC	23266	Throat Plate (large needle hole) for 143170, 143249 and 143250...
143174	23279	Feed Dog, 17 teeth (14 teeth to the inch), for 143175, for 241-12 and 241-13 Machines.....
143175XC	23279	Throat Plate for 143174, for 241-13 Machine.....
143176	-----	Trade Mark Rivet for 143262 (2)....
143179	23283	Bell Crank Plunger for 143289.....
143182	23281	Rotating Hook Oil Flow Regulating Screw Body for 143183.....
143183	23281	Rotating Hook Oil Flow Regulator complete, Nos. 51701C, 140316C and 143182.....
143184	23286	Presser Bar Bushing (lower).....
143185	23281	Feed Bar Body with two each 1607C and 51220AL, for 143187.....
143186	23281	Feed Bar Shank for 143187.....

Note: No. 143174 is regularly furnished
with 241-13 Machine.

23279 Throat Plate for 143174, for 241-13
Machine.....

Note: No. 143175 is regularly furnished
with 241-13 Machine.

----- Trade Mark Rivet for 143262 (2)....

23283 Bell Crank Plunger for 143289.....

23281 Rotating Hook Oil Flow Regulating

Screw Body for 143183.....

23281 Rotating Hook Oil Flow Regulator

complete, Nos. 51701C, 140316C

and 143182.....

23286 Presser Bar Bushing (lower).....

23281 Feed Bar Body with two each 1607C

and 51220AL, for 143187.....

23281 Feed Bar Shank for 143187.....

NUMERICAL LIST OF PARTS

NUMERICAL LIST OF PARTS

No.	Plate	Name
143197	23281	Feed Bar (Lifting adjustable) complete Nos. 704C, 143185 and 143186.....
143198	23281	Lifting Lever Connecting Rod Oil Guard (tubular).....
143191	23281	Lifting Lever Connecting Rod Oil Mist Retaining Disc (felt) for 143289.....
143195	23286	Needle Bar Oil Wick for 143202.....
143197	23272	Oil Wick for oiling Needle Bar Connecting Link, Thread Take-up Lever, Thread Take-up Lever Hinge Bearing and Thread Take-up Lever Link for 143077, 143147 and 143151.....
143200	23272	Oil Wick Oil Loader for 143077, 143147 and 143151.....
143201	23286	Slack Thread Regulator.....
143202	23286	Thread Take-up Lever Oil Guard with 143196.....
143203	23275	Arm Top Cover for 143204.....
143204	23275	Arm Top Cover with Stitch Regulator Plunger complete, Nos. 218J, 64519, 143203 and 143207.....
Note: No. 143204 is regularly furnished with these Machines.		
143205	23275	Arm Top Cover for 143206.....
143206	23275	Arm Top Cover with Stitch Regulator Plunger complete when a longer spool pin (3 1/2 in. long) is required, Nos. 218J, 64519, 143205, 143207 and 143244.....
143207	23275	Arm Top Cover Stitch Regulator Plunger for 143204 and 143206....
143221	-----	Feed Rock Shaft 143047 with 143051 (for Agents only).....
143222XC	23296	Throat Plate (small needle hole) for 143170, 143249 and 143250, for 241-11 Machine.....
143227	23280	Thread Stabilizer.....
143228	23277	Face Plate for 143231.....
Note: When ordering No. 143228 Class No. of Machine must be stated.		
143229	23277	Face Plate Thread Guard (lower) for 143231.....
143230	23277	Face Plate Thread Guard (upper) for 143231.....
143231	23277	Face Plate complete, Nos. 143228 to 143230 and two 50117J.....
Note: When ordering No. 143231, Class No. of Machine must be stated.		
143232	-----	Arm Shaft (horizontal) 143003 with 143237 for 241-11 Machine (for factory use only).....
143233	-----	Arm Shaft (horizontal) 143003 with 140359E and 143238, for 241-11 Machine (for Agents only).....

No.	Plate	Name
143234	-----	Arm Shaft (horizontal) 143003 with 143239, for 241-12 and 241-13 Machines (for factory use only)..
143235	-----	Arm Shaft (horizontal) 143003 with 140359E and 143240, for 241-12 and 241-13 Machines (for Agents only).....
143236	23272	Arm Shaft (horizontal) Screw Plug (front) Washer (fibre) for 143238 and 143240.....
143237	23272	Needle Bar Crank with 1036AL, 1065AL and 140327AL, for 143232 and 143238.....
143238	-----	Needle Bar Crank 143237 with 143236 and 143241, for 143233 (for Agents only).....
143239	23273	Needle Bar Crank with 1036AL, 1065AL and 140327AL, for 143234 and 143240, for 241-12 and 241-13 Machines.....
143240	-----	Needle Bar Crank 143239 with 143236 and 143241, for 143235, for 241-12 and 241-13 Machines (for Agents only).....
143241	23272	Thread Take-up Crank Wearing Plate for 143238 and 143240.....
143242	23281	Lifting Lever with 448AL, for 143289.....
143243	24359	Throat Plate for 52462 for 241-12 and 241-13 Machines.....
143244	23275	Arm Top Cover Spool 3 1/2 in. long with Spool Rest for 143206.....
143249	23296	Feed Dog, 18 teeth (18 teeth to the inch) for 143171 and 143222.....
143250	23296	Feed Dog, 20 teeth (20 teeth to the inch) for 143171 and 143222.....
143256	23283	Machine Base and Oil Reservoir....
143257	23283	Machine Base and Oil Reservoir Gasket (cork).....
143260	23290	Machine Base and Oil Reservoir Frame Hinge Plate Rivet for 143306 (6).....
*143262	-----	Arm with 15404 and two 143176.....
Note: Due to the accuracy required for gear alignment, Arm cannot be supplied separately and can only be sent out as a unit, Arm and Bed assembled.		
*143263	-----	Bed.....
Note: Due to the accuracy required for gear alignment, Bed cannot be supplied separately and can only be sent out as a unit, Arm and Bed assembled.		
143264	23280	Face Plate Thread Lubricator Adaptor for 143357.....

From the library of: Diamond Needle Corp

NUMERICAL LIST OF PARTS

NUMERICAL LIST OF PARTS

No.	Plate	Name
143265	23275	Balance Wheel (disc, power) 2 3/16 in. diam, pulley with two 140346AL for round belt.....
Note: No. 143265 is regularly furnished with this Machine.		
143268	23272	Bed Leg (back).....
143269	23281	Feed Lifting Rock Shaft for 143270
143270	-----	Feed Lifting Rock Shaft complete for 143271, Nos. 143041 and 143269.....
143271	-----	Feed Lifting Rock Shaft 143270 with 143045 (for Agents only)....
143277XC	23299	Throat Plate for use with 35540, for 20163 and 160327, for 241-12 and 241-13 Machines.....
143279XC	23299	Throat Plate for 20164, for collar work (first stitching) for 241-12 and 241-13 Machines.....
143280	23284	Knee Lifter Rock Shaft for 143302.
143281	23284	Knee Lifter Rock Shaft Crank with 140351AL and 143282, for 143302.
143282	-----	Knee Lifter Rock Shaft Crank Adjusting Screw 140350AL with S1649J, for 143281.....
143283	23284	Knee Lifter Rock Shaft Knee Arm for 143285.....
143284	23284	Knee Lifter Rock Shaft Knee Arm Hub with 356C and 140351AL, for 143285.....
143285	-----	Knee Lifter Rock Shaft Knee Arm complete for 143288, Nos. 2767, 143283 and 143284.....
143286	23284	Knee Lifter Rock Shaft Spring for 143302.....
143287	23284	Knee Lifter Rock Shaft Stop Dog with 140351AL for 143302.....
143288	23284	Knee Lifter Rock Shaft complete for 143289, Nos. 143285 and 143302 (for Agents only).....
143289	-----	Knee Lifter complete, Nos. 766E, 802D, 12240, 12241, 23273, 143105, 143108, 143109, 143179, 143191, 143242, 143288 and two each 158R and 1611J.....
143292	-----	Combination of Feed and Stitch Regulator Parts, Nos. 143040, 143049, 143123, 143134, 143293 and 143294.....
143293	-----	Dummy Shaft for 143292.....
143294	-----	Set of Mated Gears complete for upper shaft for 143292, Nos. 143015, 143036 and 143087.....
143295	-----	Set of Mated Gears complete, for lower shaft, Nos. 143014 and 143081.....

No.	Plate	Name
143301	-----	Rotating Hook Oil Wick (felt) for 143340.....
143302	-----	Knee Lifter Rock Shaft 143280 with 143281, 143286 and 143287, for 143288 (for Agents only).....
143306	23290	Machine Base and Oil Reservoir Frame for 143307, Nos two 16555, four each 9374, 24106 and six each 143260 and wood screws 1 1/4 in. No. 12 F.H.....
143307	-----	Machine Base and Oil Reservoir Frame complete with Long Arm Tucker, Nos. 36395 (with three wood screws 3 in. No. 12 F.H., in place of three wood screws 1 1/4 in. No. 10 F.H.) 135167, 143306 and four each 40282 and 51088R.....
143321	23287	Needle Bar (hollow) for 143322....
143322	-----	Needle Bar 143321 with 665J, 143327 and 143328, for 241-12 and 241-13 Machines.....
143323	23287	Needle Bar Bushing (lower) for 241-12 and 241-13 Machines.....
143324	23286	Needle Bar Bushing (upper).....
143325	-----	Needle Bar Connecting Link 143054 with 143326, for 143330 and 143332.....
143326	23286	Needle Bar Connecting Stud with 207E, for 143325.....
143327	23287	Needle Bar Thread Guard for 143322 and 143362.....
143328	23287	Needle Clamp with 140119AL, for 143322 and 143362.....
143329	23286	Thread Take-up complete for 241-11 and 241-12 Machines, Nos. 143097 to 143099, 143330 and eighteen 143056.....
143330	23286	Thread Take-up Crank with 140231C, 143058, 143325 and eighteen 143056, for 143329.....
143331	23288	Thread Take-up complete for 241-13 Machine, Nos. 143097 to 143099, 143332 and eighteen 143056.....
143332	23288	Thread Take-up Crank with 140231C, 143058, 143325 and eighteen 143056, for 143331.....
143335	23286	Needle Bar (hollow) with 140239AL, for 241-11 Machine.....
143336	23286	Needle Bar Bushing (lower) for 241-11 Machine.....
143337	23286	Presser Bar (hollow).....
143338	23286	Presser Bar Guide Bracket with 223C and 453AL.....

NUMERICAL LIST OF PARTS

No.	Plate	Name
143339	23286	Pressure Regulating Thumb Screw and Presser Bar Guide.....
143340	23286	Rotating Hook with 143301 and two 1253AL, for 143341.....
143341	-----	Rotating Hook 143340 with 143351, 270982, and four 1053E, for 143342 and 143343.....
143342	-----	Rotating Hook 143341 with 40274, 143346 and three 1367E, for 143344.....
143343	-----	Rotating Hook 143341 with 40274 and three 1367E (for Agents only)
143344	23286	Rotating Hook 143342 with 52237...
143345	-----	Rotating Hook Bobbin Case 52237 with 143346 (for Agents only)...
143346	23286	Rotating Hook Bobbin Case Holder for 143342 and 143345.....
143347	23281	Rotating Hook Shaft with 143350, for 143348.....
143348	-----	Rotating Hook Shaft 143347 with 143183.....
143349	23281	Rotating Hook Shaft Oil Filter Wick Holder for 143350.....
143350	23281	Rotating Hook Shaft Oil Filter complete for 143347, No. 143042 and 143349.....
143351	-----	Rotating Hook Wiper for 143341....
143353	23280	Face Plate Thread Lubricator Oil Pad Holder for 143354.....
143354	-----	Face Plate Thread Lubricator Oil Pad Holder 143353 with 62819, 62827 and 143355, for 143356....
143355	23280	Face Plate Thread Lubricator Oil Pad Retainer for 143354.....
143356	23280	Face Plate Thread Lubricator complete for 143357, Nos. 8068, 17822, 124371 and 143354.....
143357	23280	Face Plate Thread Lubricator 143356, with 140050J and 143264.
143359	-----	Machine Base and Oil Reservoir Screw Retainer (for shipping purposes only).....
143360	-----	Machine Base and Oil Reservoir Screw Cotter Pin (for shipping purposes only).....
143361	-----	Needle Bar (hollow) for 143362....
143362	-----	Needle Bar 143361 with 665J, 143327 and 143328, for 241-13 Machine (for size 16 x 21 needles).....
143363	23275	Balance Wheel (disc, power) "V" Belt Groove (outside diameter of Belt Groove 2.9 in.) with two 51283AL for "V" Belt.....

NUMERICAL LIST OF PARTS

No.	Plate	Name
150002	23289	Thread Unwinder Spool Rest Cushion (felt) for 225258 (2).....
150842	23248	Feed Lifting Rock Shaft (front) Screw Center Oil Guard with 22436, 7/16 in. No. 2 Shoe Tack and wood screw 1/2 in. No. 7 R.H. Blacked (Accessories).....
160315	24352	Feed Dog, 13 teeth (16 teeth to the inch) for 160317, for use with 160318 for 241-11 Machine.....
160316	24352	Hemmer (foot) with 121981, for 1/8 in. hem, for hemming slips, for 241-11 Machine.....
160317X0	24352	Throat Plate (small needle hole) for 160315, for use with 160316 and 160318 for 241-11 Machine....
160318	24352	Hemmer (foot) with 120939, for 1/8 in. hem, for hemming shirts, for 160315 and 160317, for 241-11 Machine.....
160319	24358	Edge Guide on Shank (adjustable) for turning cloth upward to feed into Hemmer (foot) No. 160321, for hemming handkerchiefs for use with 52031 for 241-11 Machine....
160320	24358	Hemmer (foot) Extension Guide for 160321.....
160321	24359	Hemmer (foot) with 25888, 160320 and two 234E, for 1/16 in. hem, for use with 52031 and 52033, for hemming handkerchiefs, for 241-11 Machine.....
160322	24352	Presser Foot Plate for 160324.....
160323	24352	Presser Foot Shank for 160324.....
160324	24352	Presser Foot (hinged) complete for use with 160326, Nos. 26278, 160322 and 160323.....
160325	24352	Hemmer on Shank for 160326.....
160326	24352	Hemmer on Shank (adjustable, hinged) complete for 3/8 in. to 5/8 in. hem, for hemming bottoms of pajamas and shorts, for 241-11 Machine for use with 160324, Nos. 940W, 7071, 28972, 35610, 51224W, 120427 and 160325.....
160327	24353	Scroll Hemmer on Shank for handkerchiefs and slips, for 1/8 in. hem
160328	24353	Presser Foot Plate for 160330.....
160329	24353	Presser Foot Shank for 160330.....
160330	24353	Presser Foot (spring hinged) complete for 160327, Nos. 26231, 62527, 160328 and 160329.....
160331	24352	Hemmer (foot) with 120939, for 3/16 in. hem, with guide on bottom to the right of needle hole for hemming shirt centers, for 241-11 Machine.....

No.	Plate	Name
160330X	24352	Throat Plate for 19474, for use with 160371, for 241-11 Machine..
160377	24357	Strip Folder on Shank with Hemmer for attaching button stays on shirt fronts, for 241-11 Machine.
160374	14757	Presser Foot with Edge Guide on left hand side, for attaching button stays on shirts fronts, for use with 160332, for 241-11 Machine.....
160335	24351	Edge Folder with Strip Folder on Shank for French button facing, for 241-11 Machine.....
160376	14351	Feed Dog, 18 teeth (16 teeth to the inch), for 160341, for 241-11 Machine, for use with Edge Folder No. 160335.....
160377	24351	Presser Foot Edge Guide (left hand) for 160340.....
160338	24351	Presser Foot Marker Guide (right hand) for 160340.....
160379	24351	Presser Foot Plate, for 160340.....
160341	24351	Presser Foot (spring hinged) complete for 160311, for 241-11 Machine, Nos. 24352, 24376, 160337 to 160339, 160406 and four 337J.....
160341X	24351	Throat Plate for 160338, for 241-11 Machine, for use with Edge Folder No. 160335.....
160341	23285	Presser Foot for darning, for use with 13088 and 12422.....
160342	17300	Hemmer Foot with 25828 (plain bottom, taper hem groove) for 1/16 in. hem.....
160344	22722	Hemmer (Foot) with 160939, for 1/16 in. hem.....
160345	24355	Presser Foot (blank)..... Note: No. 160345 is furnished soft for grooving to suit cord.
160346	23200	Presser Foot, with 228J, with needle hole on right hand side, for 3/64 in. stitching margin....
160347	23300	Presser Foot, with 228J, with needle hole on right hand side, for 1/64 in. stitching margin....
160348	23300	Presser Foot, with 228J, with needle hole on left hand side, for 1/32 in. stitching margin....
160349	24355	Presser Foot, for binding.....
160350	24355	Presser Foot, for 3/32 in. to 5/8 in. stitching margin..... Note: When ordering No. 160350, state margin required.
160351	24355	Presser Foot for binding, for use with 26250.....

No.	Plate	Name
160352	24355	Presser Foot for binding.....
160353	24355	Presser Foot Plate for 160355.....
160354	24355	Presser Foot Shank for 160355.....
160355	24355	Presser Foot (hinged) complete for binding, Nos. 26276, 160352 and 160354.....
160356	24355	Presser Foot for French Braiding with groove on bottom to the right of needle hole and braid slot on top.....
160357	23285	Feed Dog, 18 teeth (12 teeth to the inch) for 160358, for tailor work.
160354X	23285	Throat Plate for 160357, for tailor work.....
160406	24351	Presser Foot Shank, for 160340.....
160448	23292	Ruffler Needle Clamp with 50203F, for 160449.....
160449	23292	Ruffler 121122 with 120819 and 160448, for 241-12 and 241-13 Machines.....
192349	23276	Binder Releasing Lever Spring Position Stud for 121733.....
200056E	23253	Bobbin Winder Stop Latch Screw for 259431 and 259462.....
200082D	23253	Bobbin Winder Tension Bracket Screw for 259431 and 259462.....
200112F	23253	Bobbin Winder Brake Clamp Screw for 259431 and 259462.....
200299H	23253	Bobbin Winder Stop Latch Trip Lever Hinge Screw for 259431 and 259462.
200330C	23253	Bobbin Winder Pulley Set Screw for 225368 and 259461.....
200383C	23289	Thread Unwinder Spool Rest Rod Set Screw for 252658.....
201018C	23289	Thread Unwinder Spool Rest Set Screw for 225257.....
201499B	23253	Bobbin Winder Tension Stud for 225461.....
201572B	23253	Bobbin Winder Tension Stud Thumb Nut for 225462.....
201596J	23289	Thread Unwinder Thread Guide Lock Nut for 225258.....
201699F	23298	Roller Ball Retaining Nut for 51901.
202277	23253	Bobbin Winder Frame Oil Packing (wick) for 225453.....
202478	23253	Bobbin Winder Stop Latch Trip Lever for 259431 and 259462.....
206417	23298	Roller Ball 1/16 in. Diam., for 51901 (28).....
225257	23289	Thread Unwinder Spool Rest with 201018C, for 225258.....
225258	23289	Thread Unwinder complete for two spools or two large cones of thread, Nos. 201696J, 225257, 225324, 225326, 225388, 259658, two each 150203, 225391 and three wood screws 1/8 in. No. 12 F.H....
225322	23289	Thread Unwinder Thread Guide Rod Washer for 225324.....

NUMERICAL LIST OF PARTS

NUMERICAL LIST OF PARTS

No.	Plate	Name
221324	22139	Thread Unwinder Thread Guide Rod with 200A1 and 225322, for 225258
221328	22289	Thread Unwinder Thread Guide Position Cup for 225258.....
221368	22289	Bobbin Winder Pulley with 200380C, for 259431.....
225381	22289	Bobbin Winder Spindle for 259431 and 259462.....
225386	22289	Thread Unwinder Spool Rest Rod for 225258.....
225390	22289	Thread Unwinder Thread Cone Holder for inverted cones, for 225258.....
Note: No. 225390 is used with, but not included in No. 225258.		
225391	22289	Thread Unwinder Thread Guide for 225258 (2).....
225419	22289	Bobbin Winder Frame Oil Well Cap for 225453.....
225444	22289	Bobbin Winder Stop Latch for 259431 and 259462.....
225457	22289	Bobbin Winder Frame with 202277 and 225439, for 259431 and 259462.....
225464	22289	Bobbin Winder Frame Hinge Pin for 259431 and 259462.....
225468	22289	Bobbin Winder Frame Spring for 259431 and 259462.....
225476	22289	Bobbin Winder Frame Spring Plunger for 259431 and 259462.....
225458	22289	Bobbin Winder Stop Latch Thumb Lever for 259431 and 259462.....
227459	22289	Bobbin Winder Stop Latch Thumb Lever Hinge Stud for 259431 and 259462.....
228459	22289	Bobbin Winder Stop Latch Thumb Lever Joint Stud for 259431 and 259462.....
225461	22253	Bobbin Winder Tension Bracket with 201499B, for 225462.....
225462	22253	Bobbin Winder Tension Bracket complete for 259431 and 259462, Nos. 13710, 201572B, 225461 and two 2102.....
229326	22253	Bobbin Winder Tension Bracket Screw Washer for 259431 and 259462.....
259428	22253	Bobbin Winder Brake (leather) for 259431 and 259462.....
259429	22253	Bobbin Winder Brake Clamp for 259431 and 259462.....
259430	22253	Bobbin Winder and Tension Bracket Base for 259431 and 259462.....
259431	22253	Bobbin Winder (round belt) complete Nos. 200056E, 200082D, 200113F, 200299H, 202478, 225368, 225381, 225444, 225453 to 225456, 225458, 225462, 228026, 259428 to 259430 and two each 225459 and wood screws 3/4 in. No. 12 R.H.B.....
212461	22253	Bobbin Winder Pulley with 200380C, for 259462.....

No.	Plate	Name
259462	22253	Bobbin Winder (swinging automatic, right hand) complete for Power Table "V" belt drive, Nos. 200056E, 200082D, 200113F, 200299H, 202478, 225381, 225444, 225453 to 225456, 225458, 225462, 228026, 259428 to 259430, 259461 and two each 225459 and wood screws 3/4 in. No. 12 R.H.....
259658	23289	Thread Unwinder Spool Stand with 200583C, for 225258.....
270083	23286	Rotating Hook Thread Guard for 143541.....
350104F	23298	Roller Screw for 51901.....
701872	23272	Stitch Regulator Plunger Hole Plug Screw Washer.....

From the library of: Diamond Needle Corp

22920 - 2/3

120742

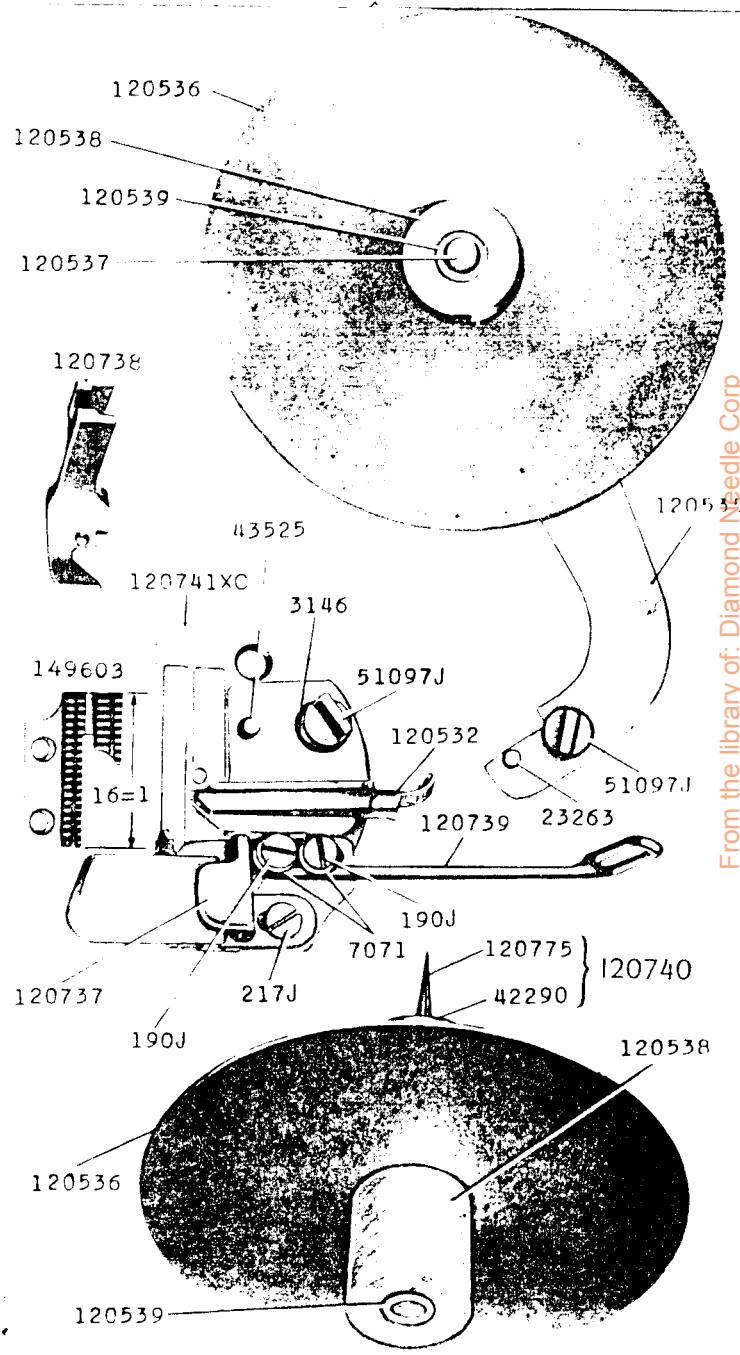

SINGER Needles should be used
 in SINGER Machines
 These Needles and their Containers
 are marked with the
 Company's Trade Mark "SIMANCO.**" 1

Needles in Containers marked
 "FOR SINGER MACHINES"
 are NOT SINGER made needles. 2

From the library of: Diamond Needle Corp

23212 - 1/2

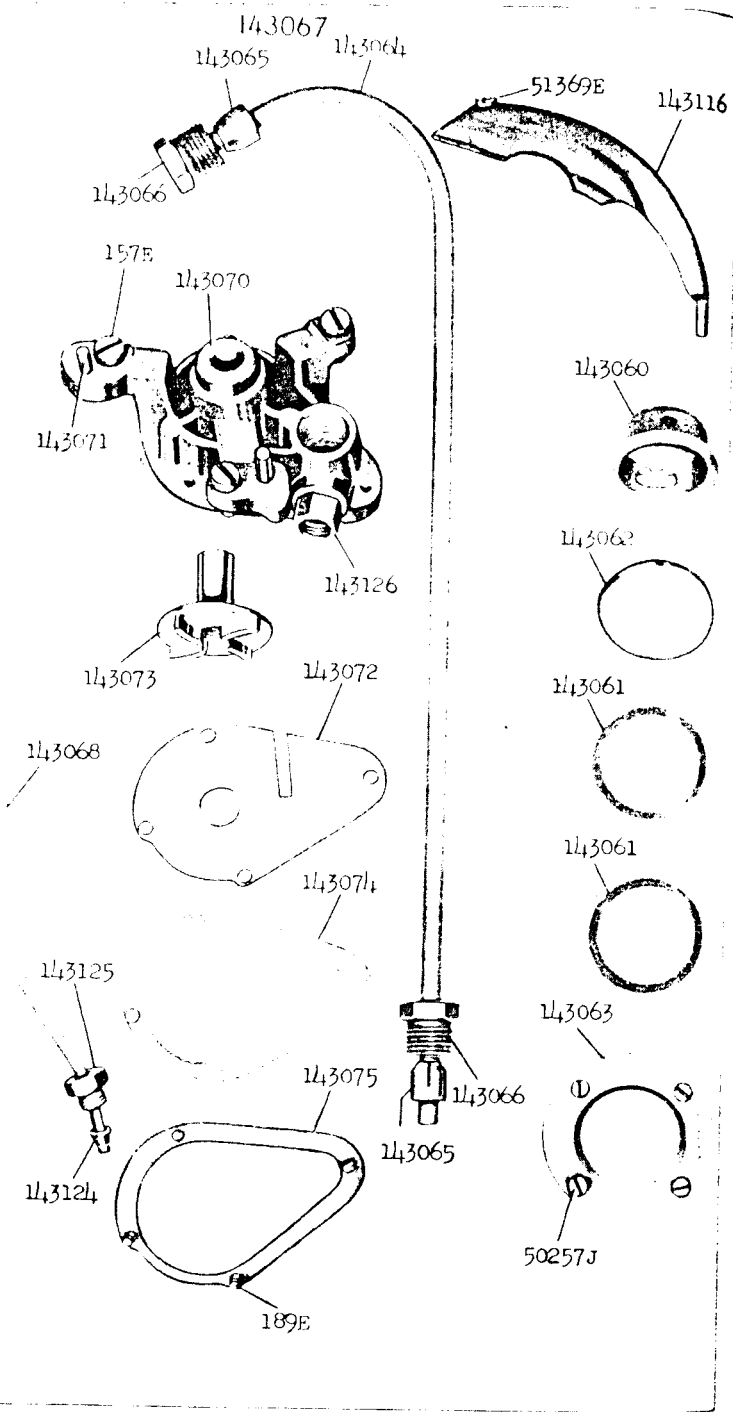

23224 - 2/3

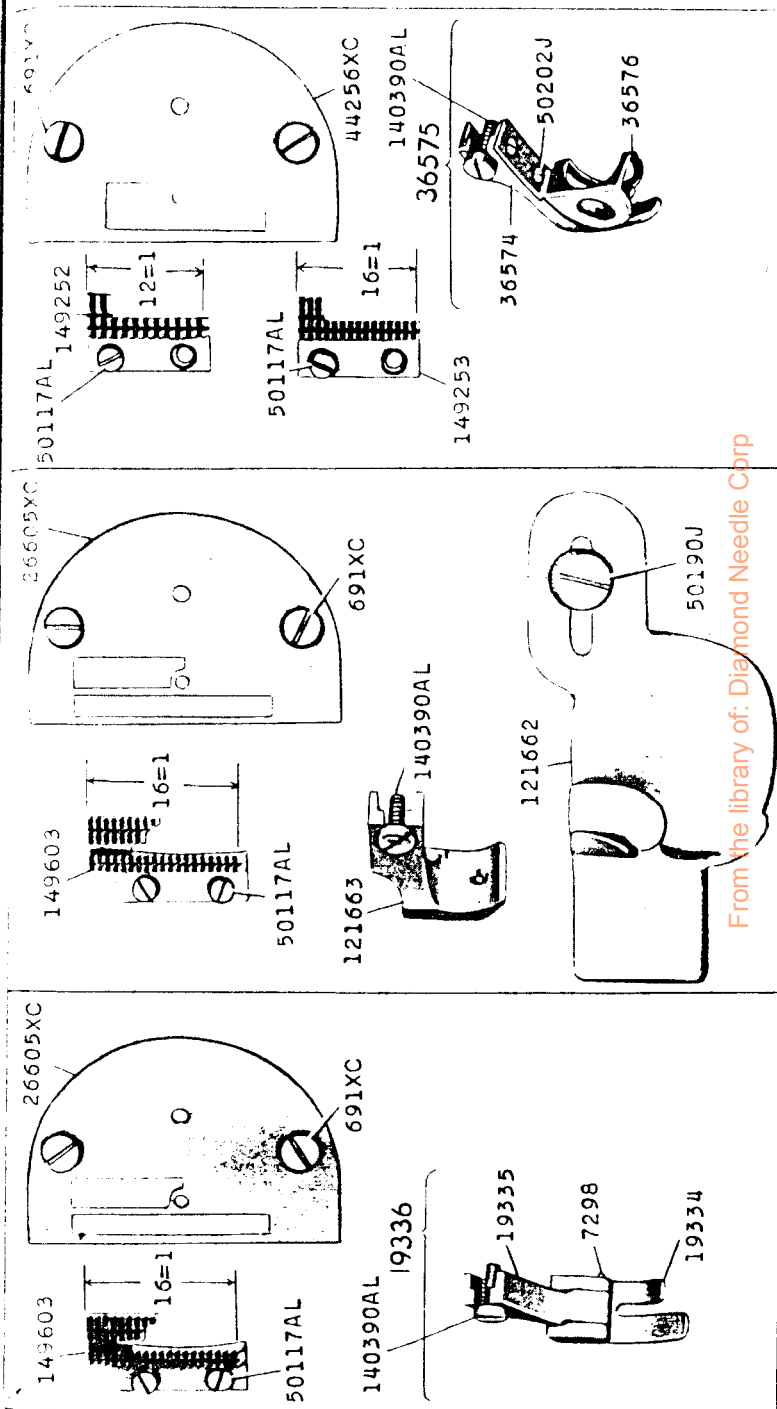

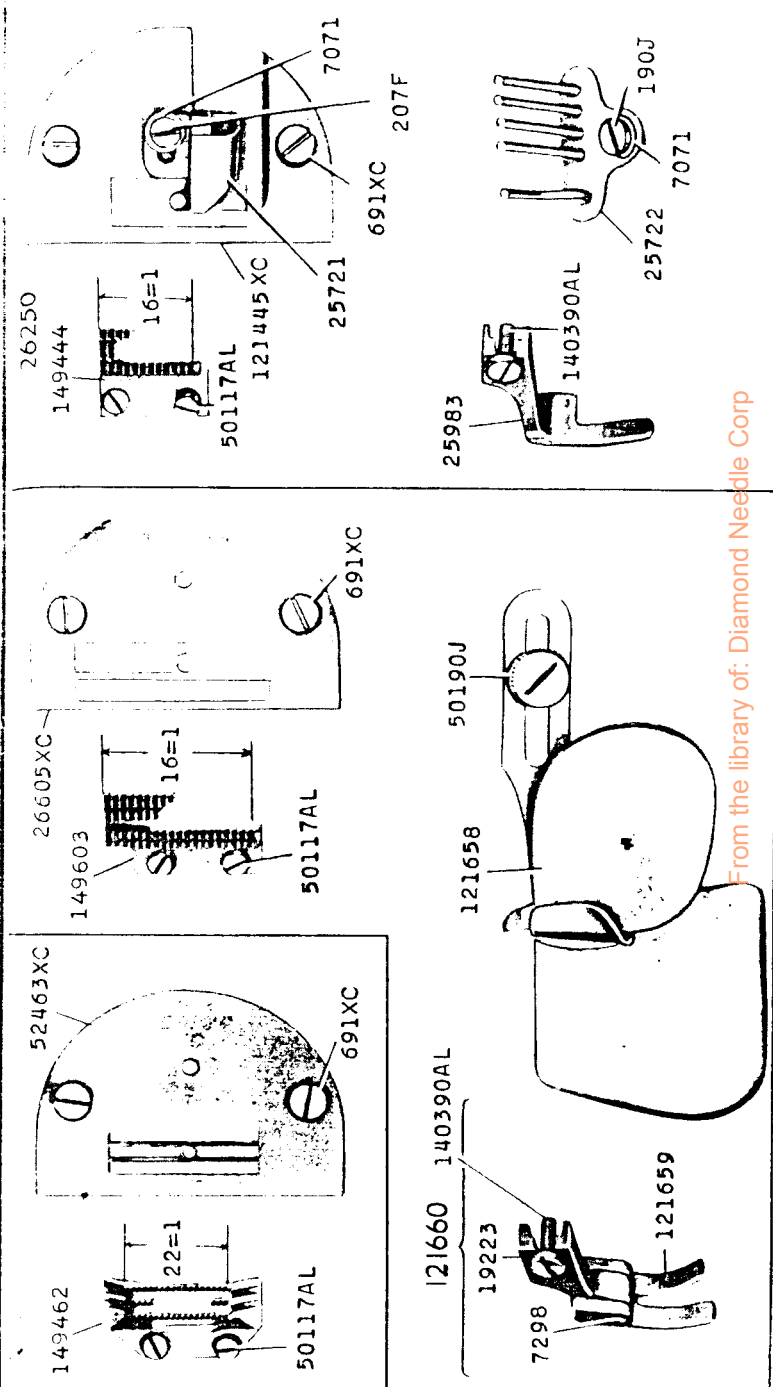
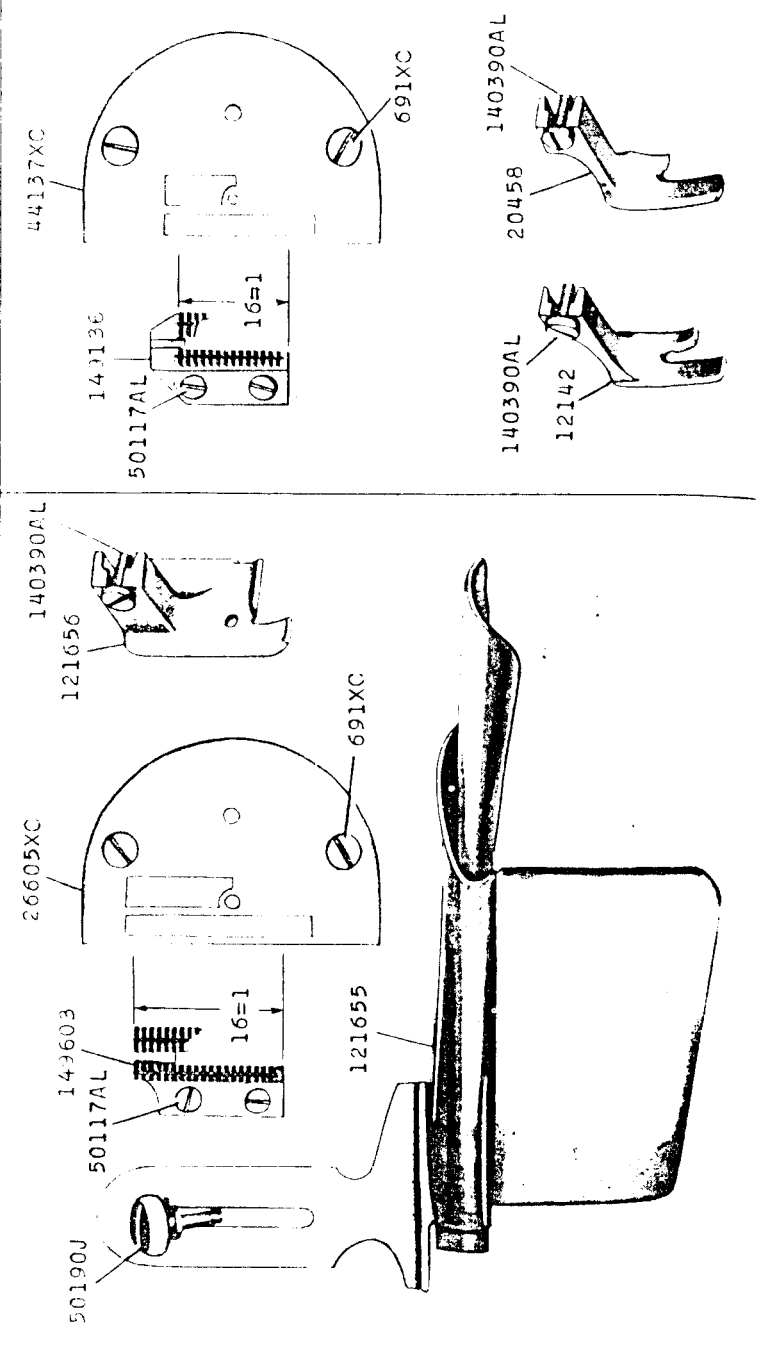

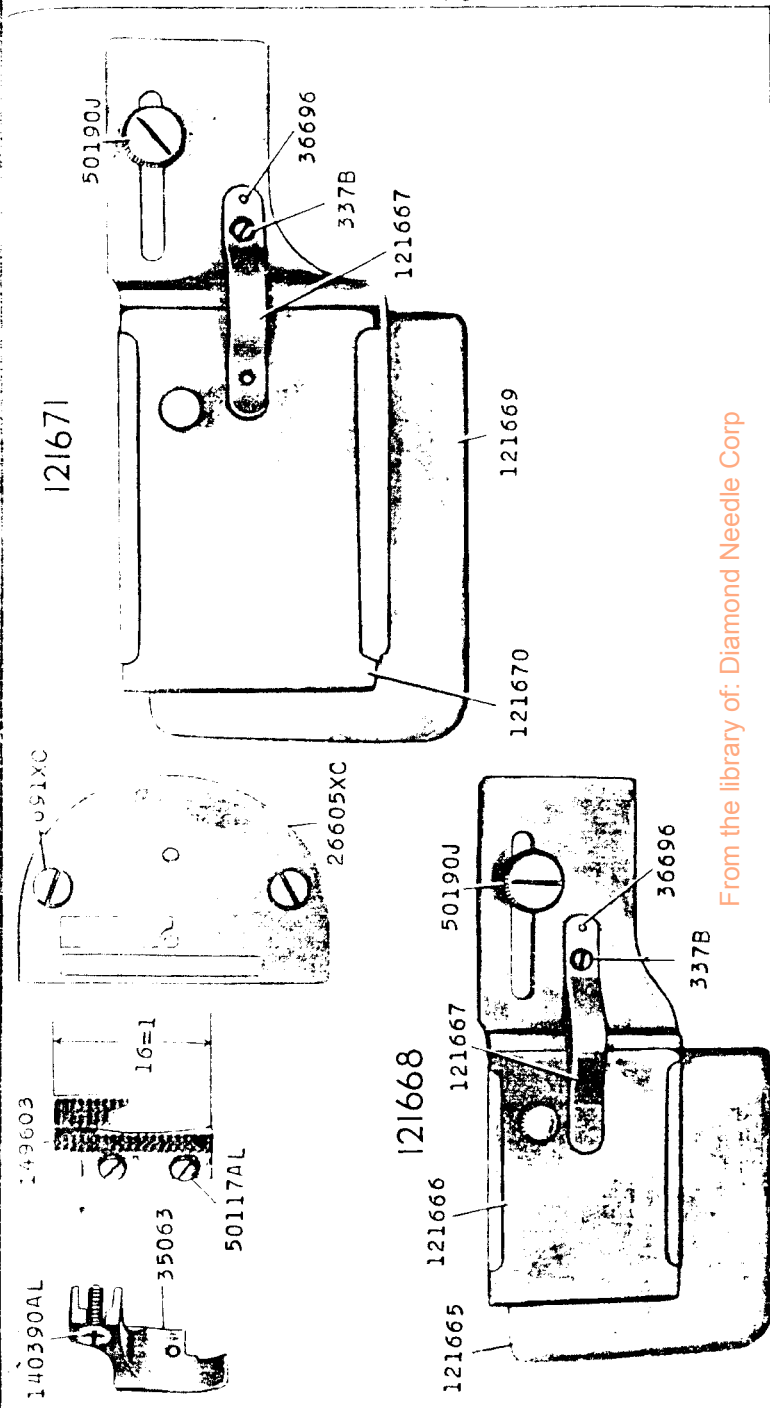

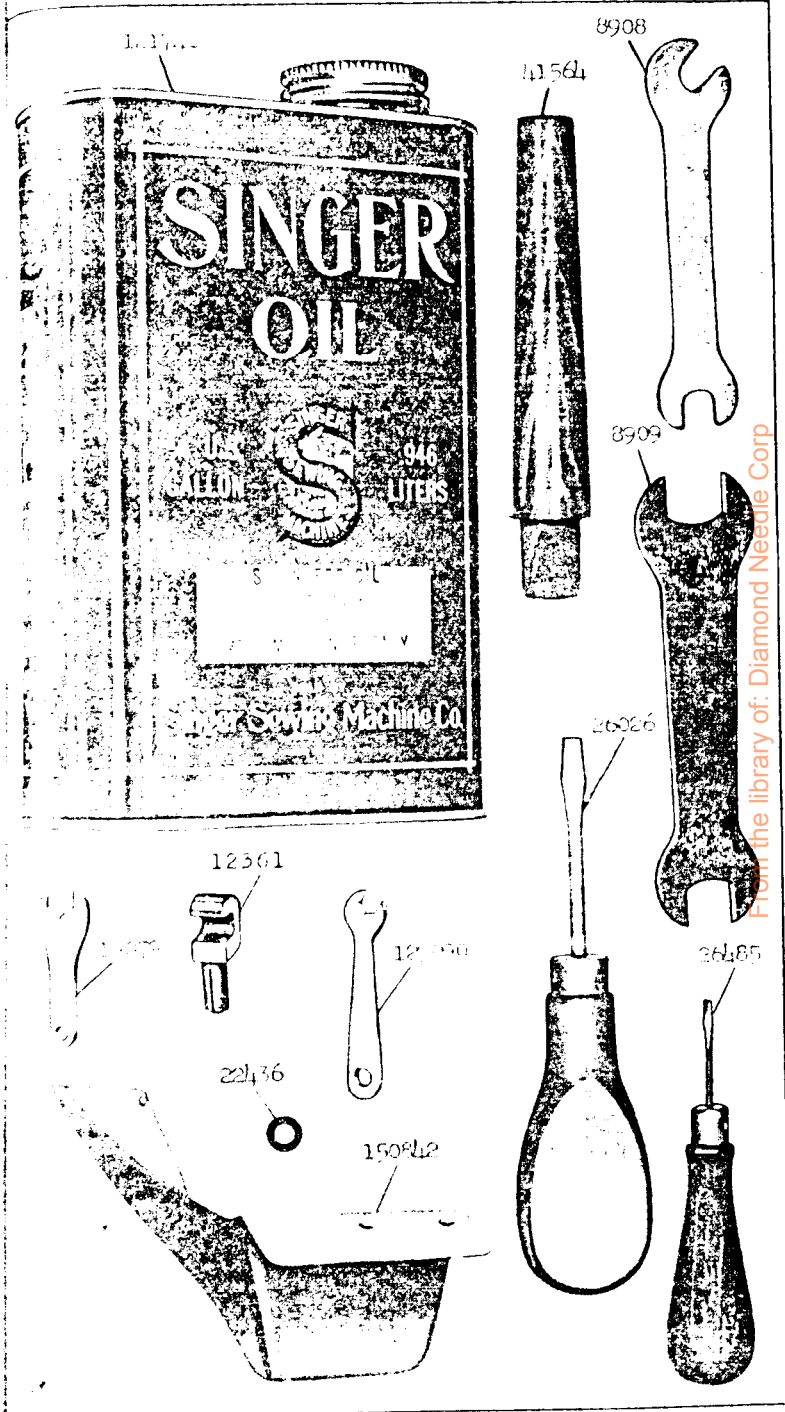
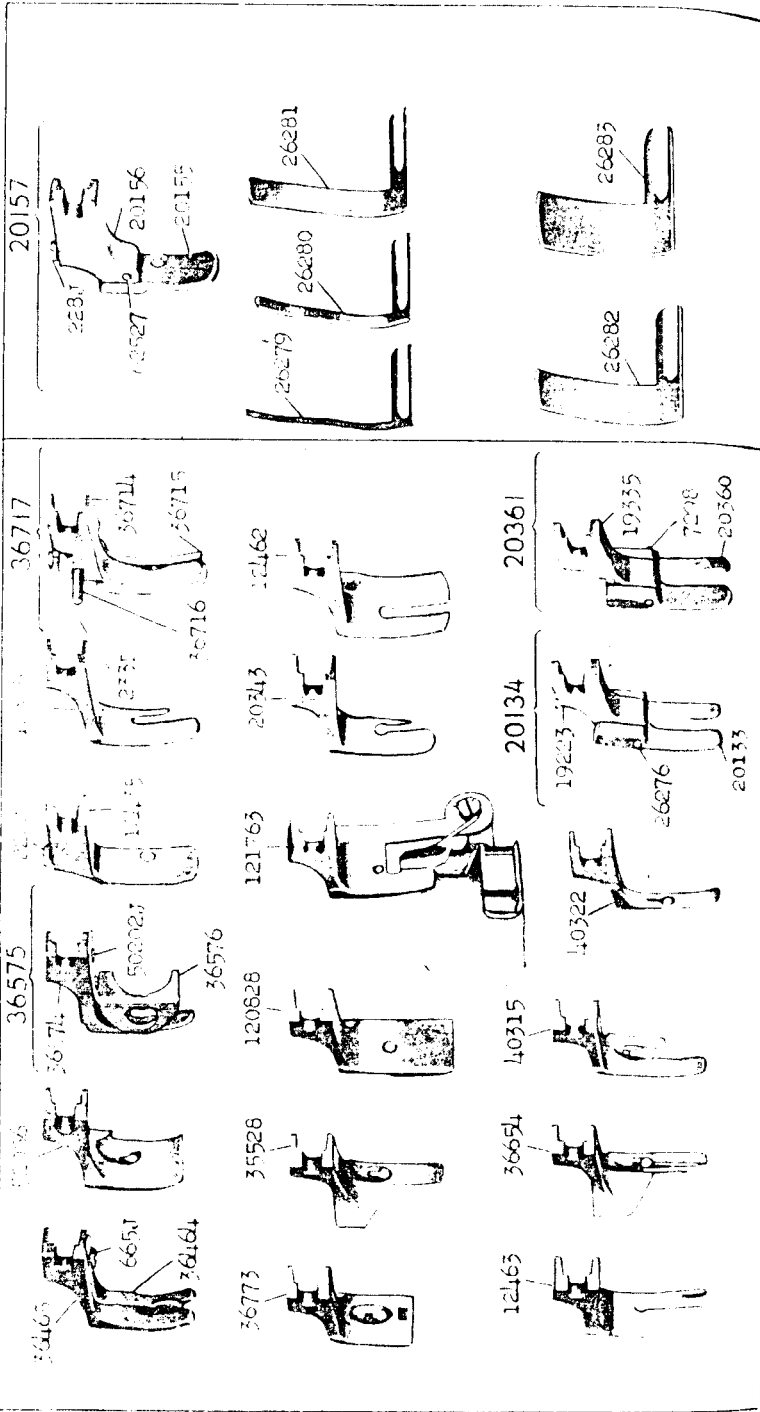

23253 - 3/8

259431

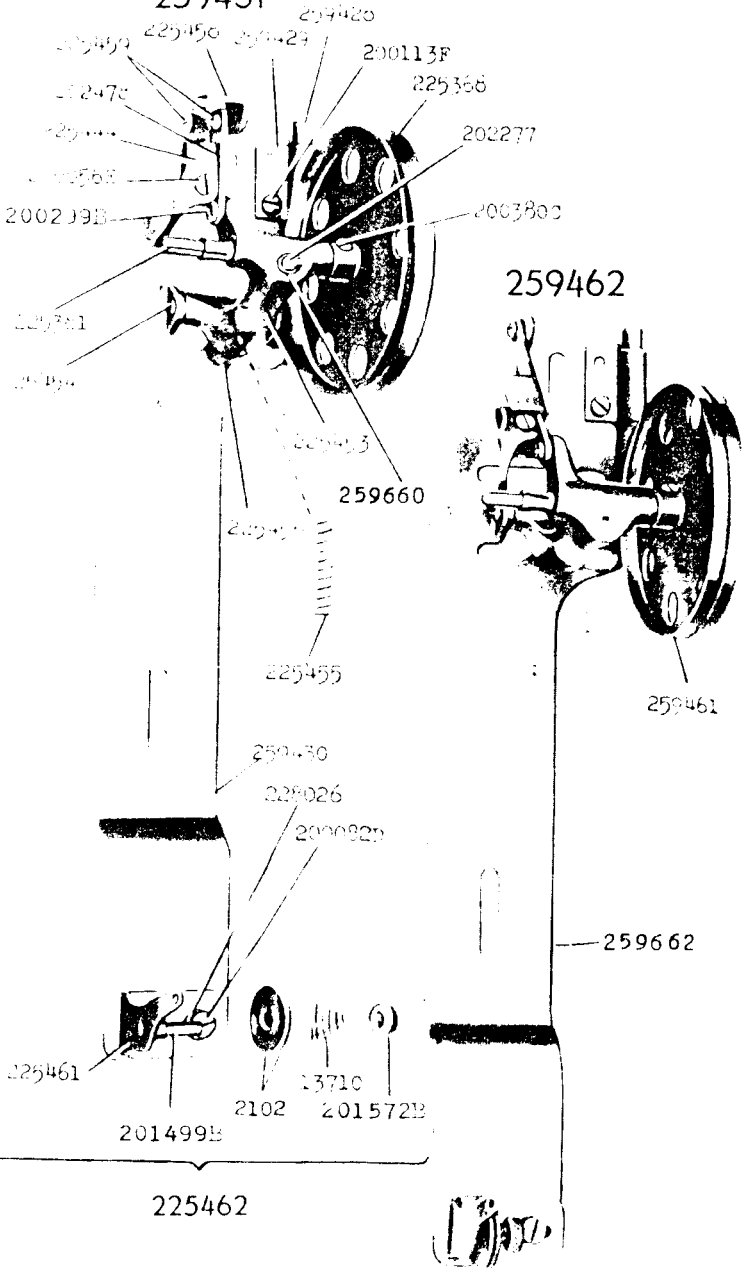

23255 - 2/3

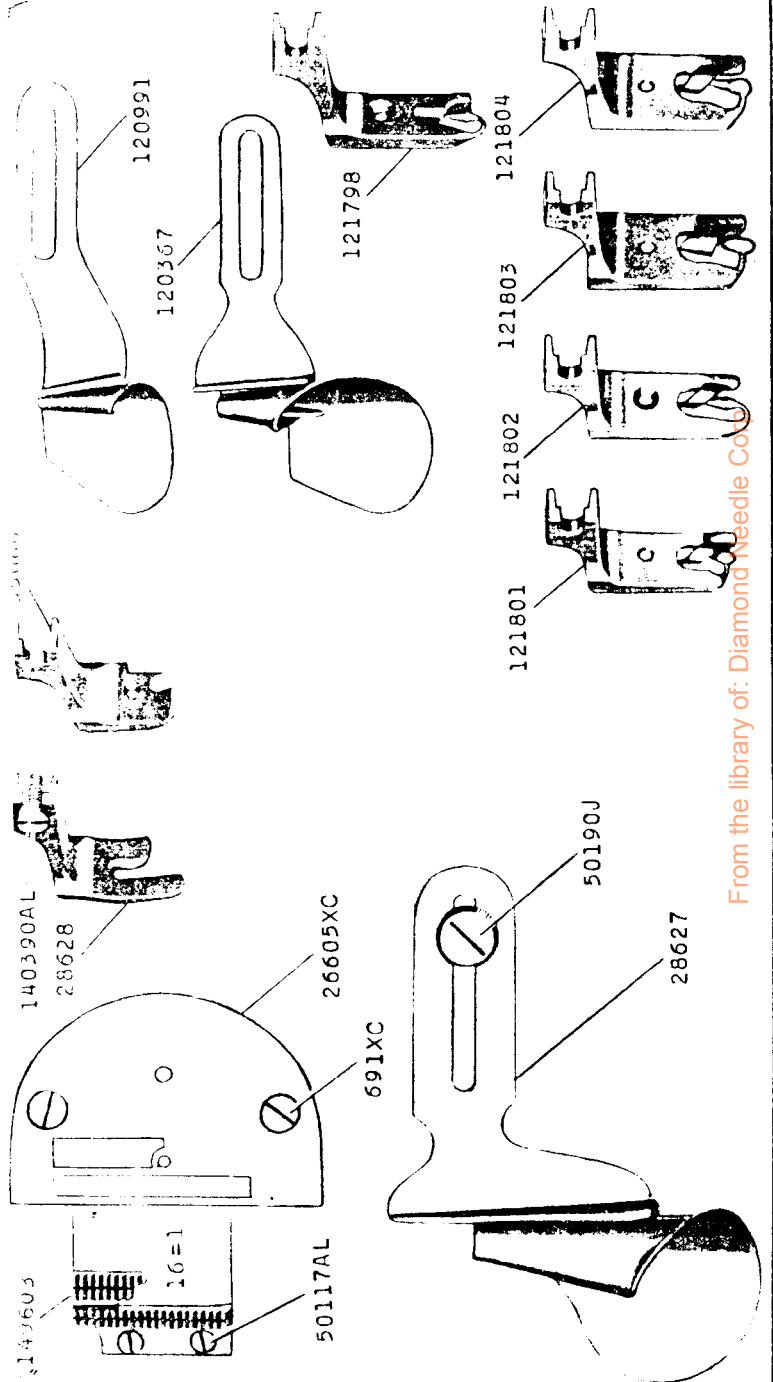

23263 - 2/3

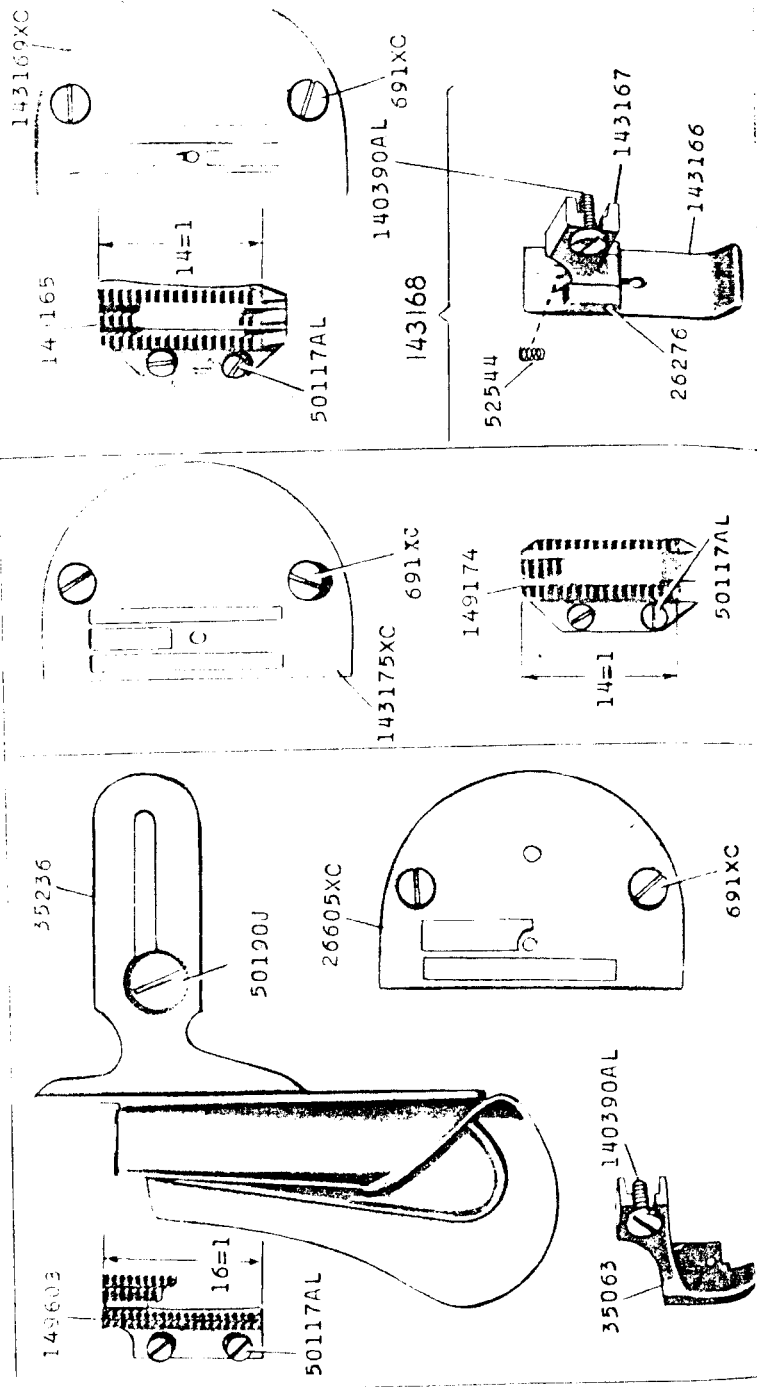

23266 - 2/3

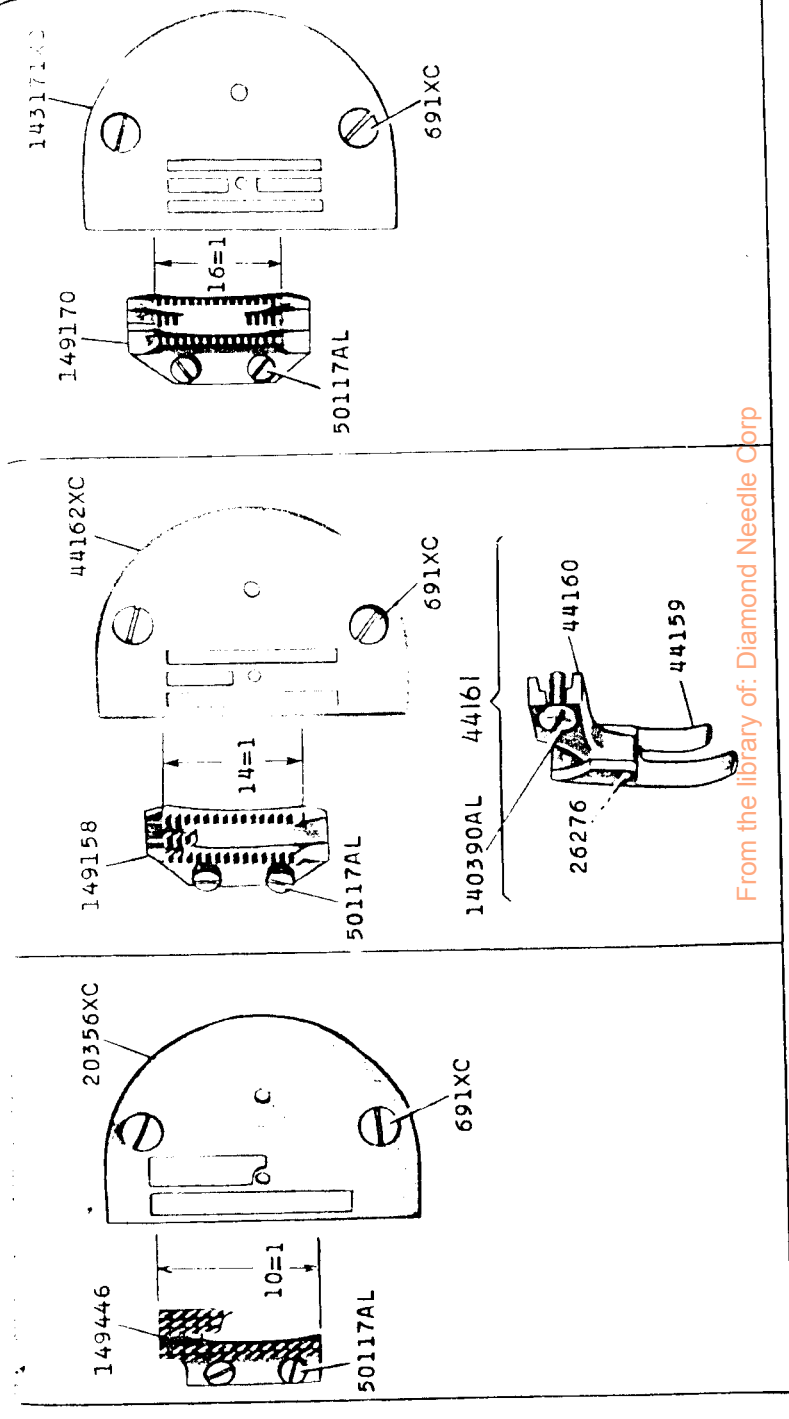

From the library of: Diamond Needle Corp

23268-2/3

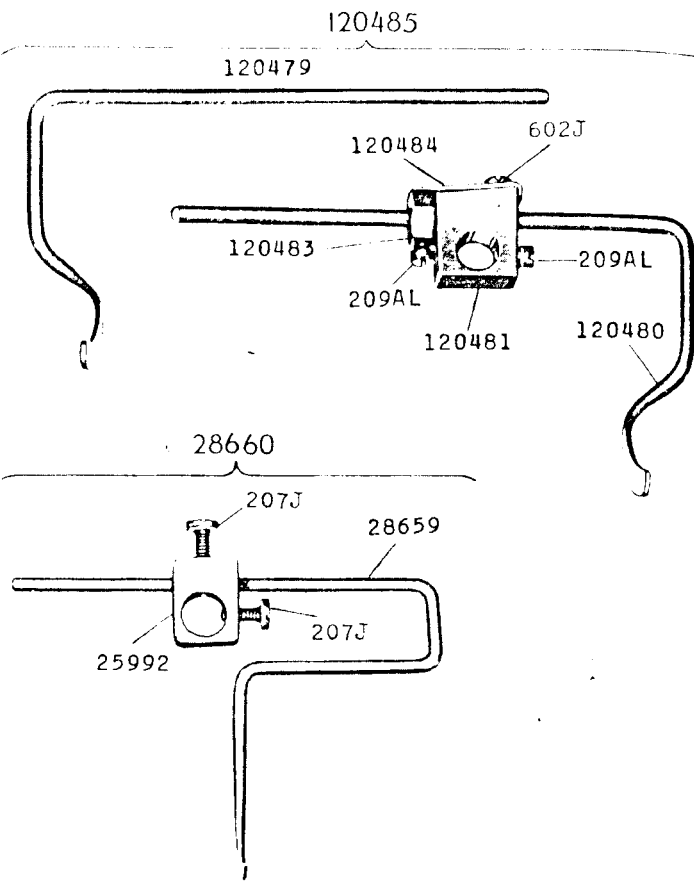

23272 - 1/3

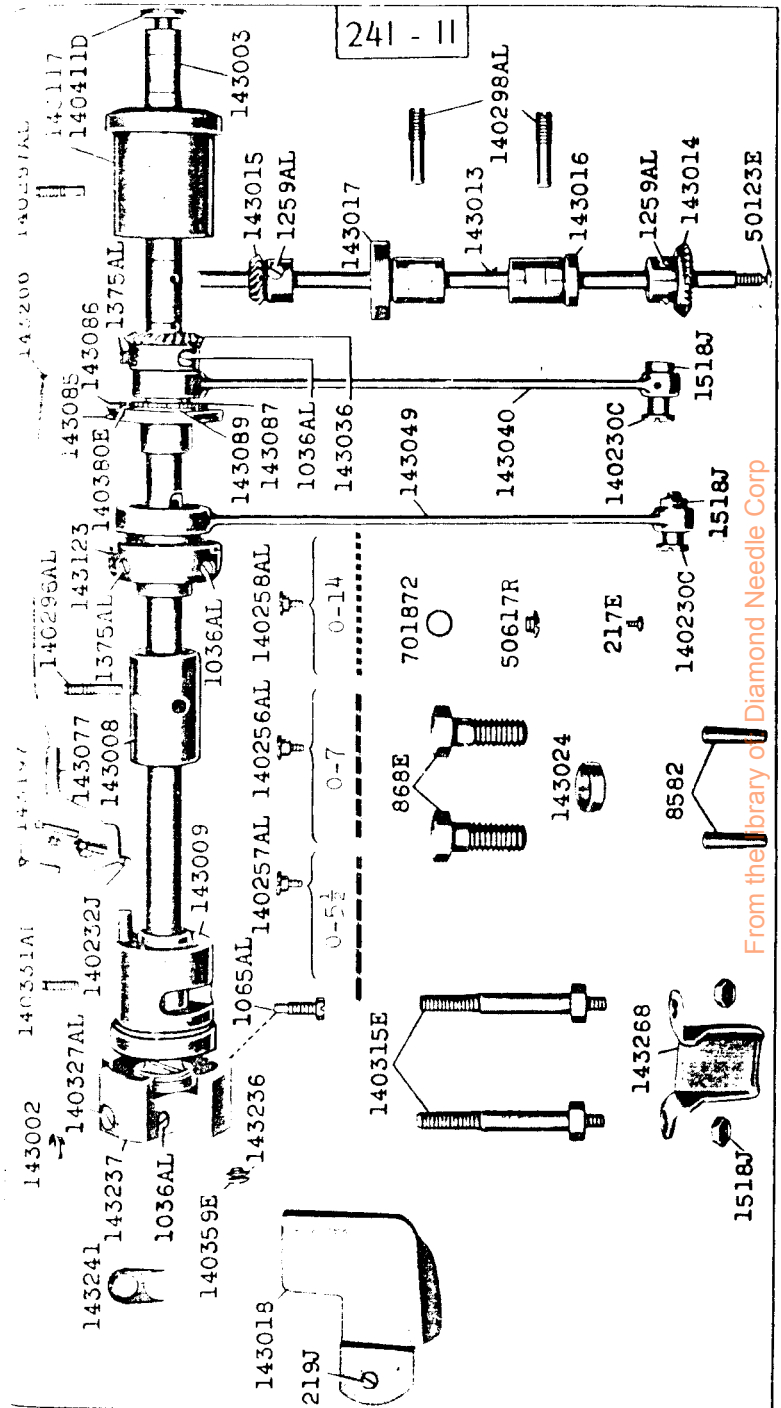

23273 - 1/3

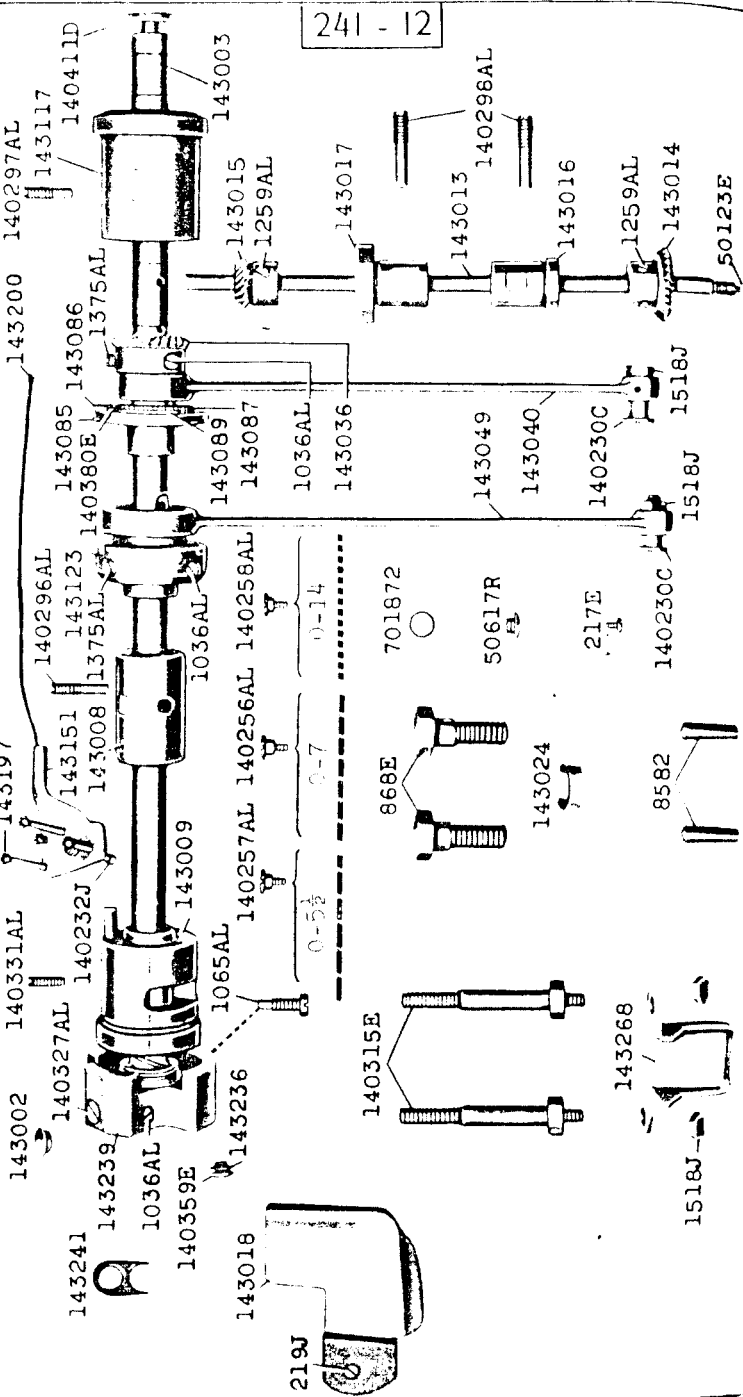

23274 - 1/3

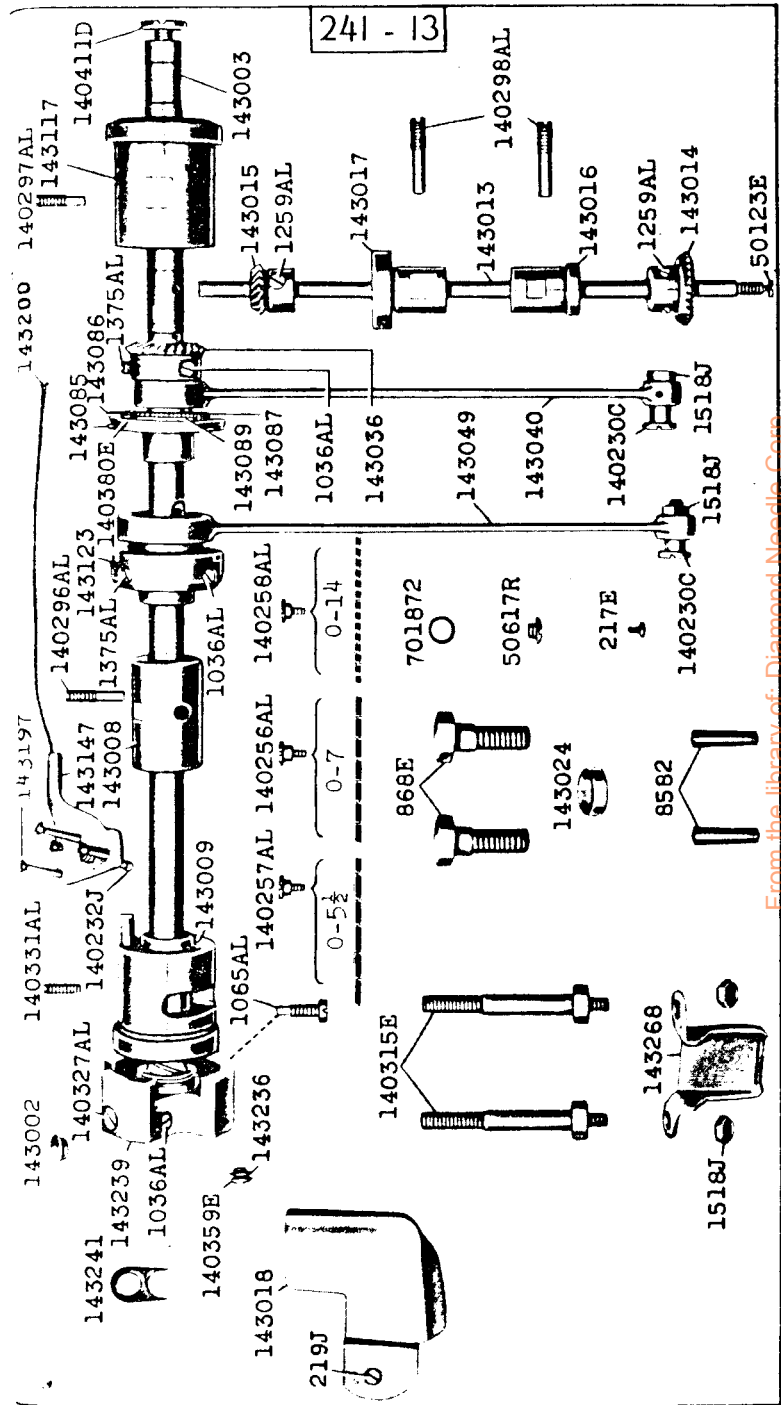

23275 - 1/2

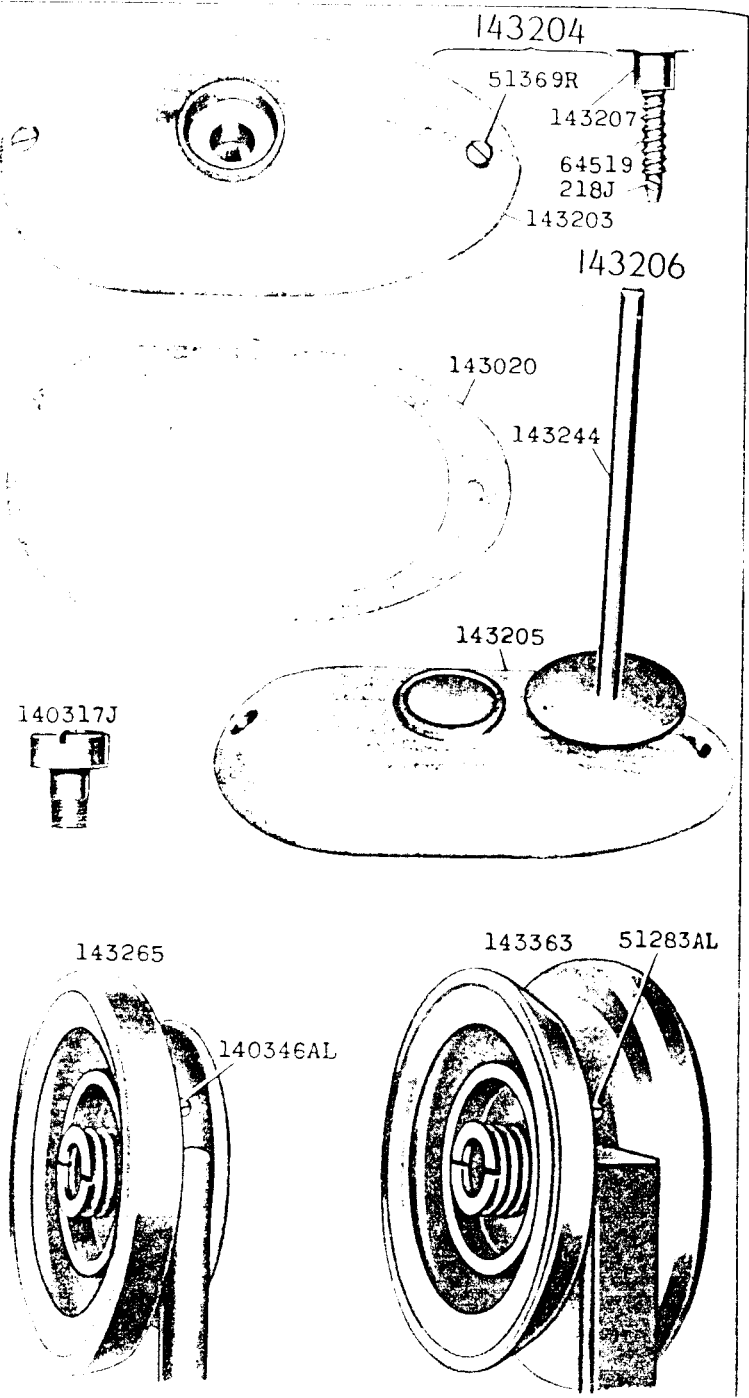

23276 - 2/3

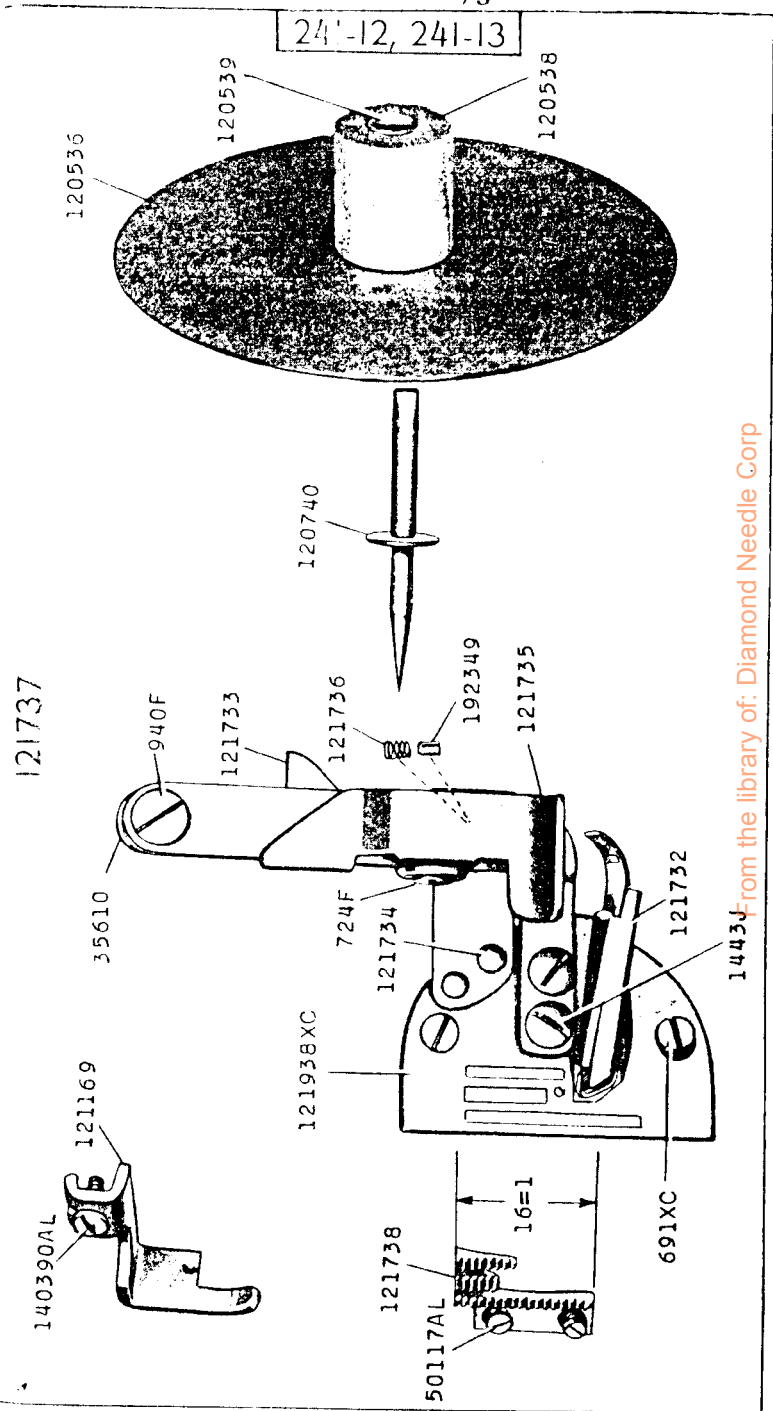

23277 - 1/2

143231

241 - II

143231

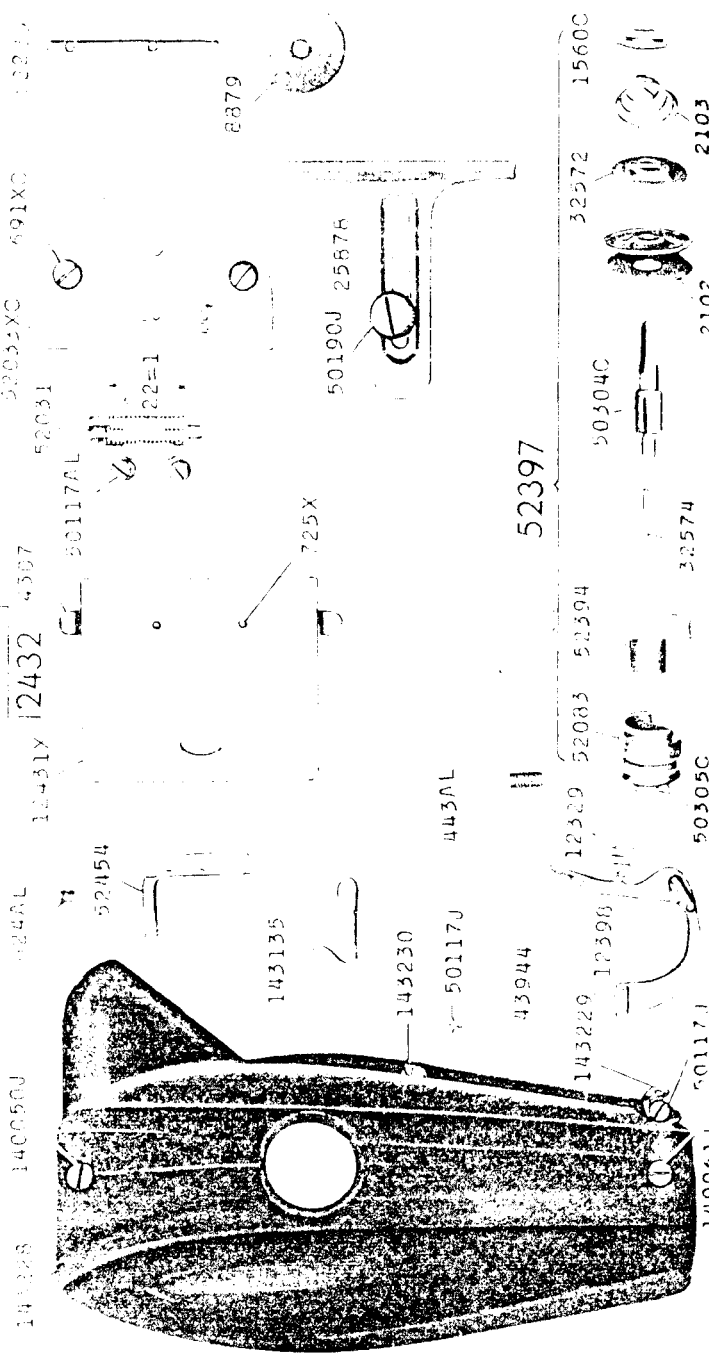

23278 - 1/2

143231

241 - 12

143231

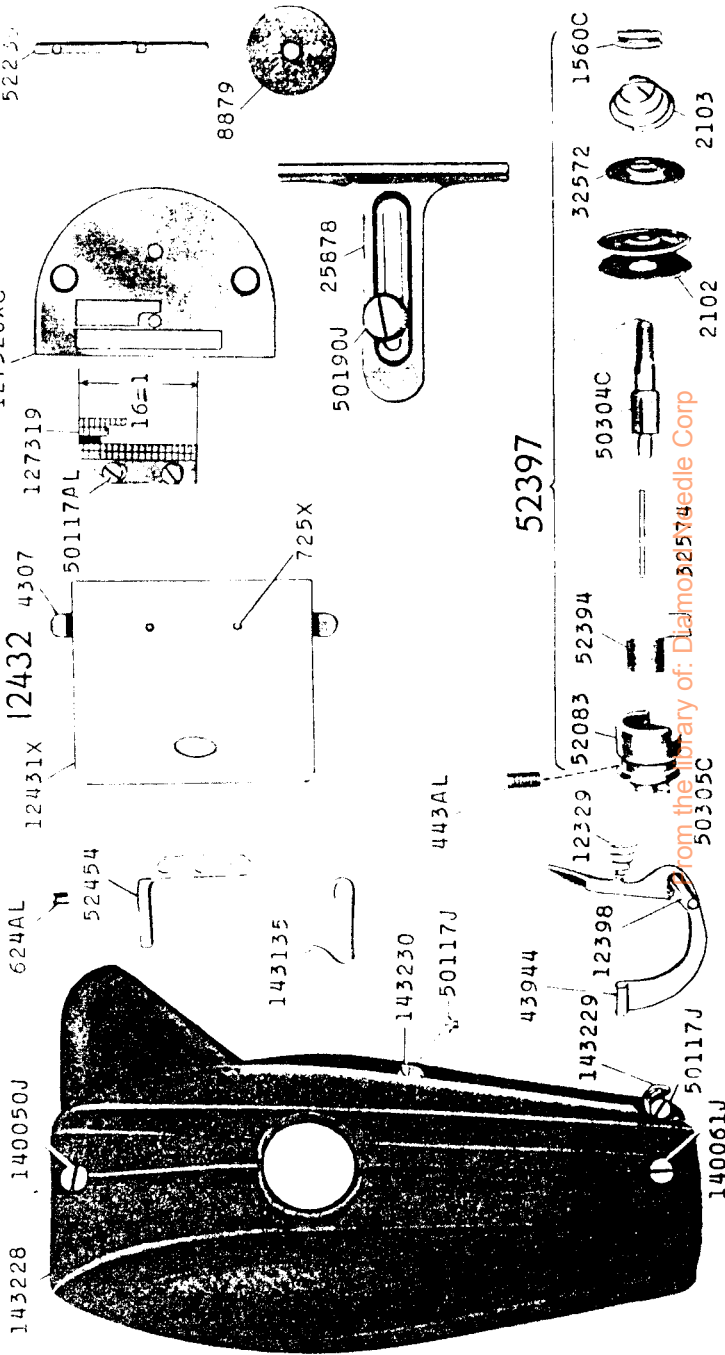

from the library of: Daimler-Benz AG

23279 - 1/2

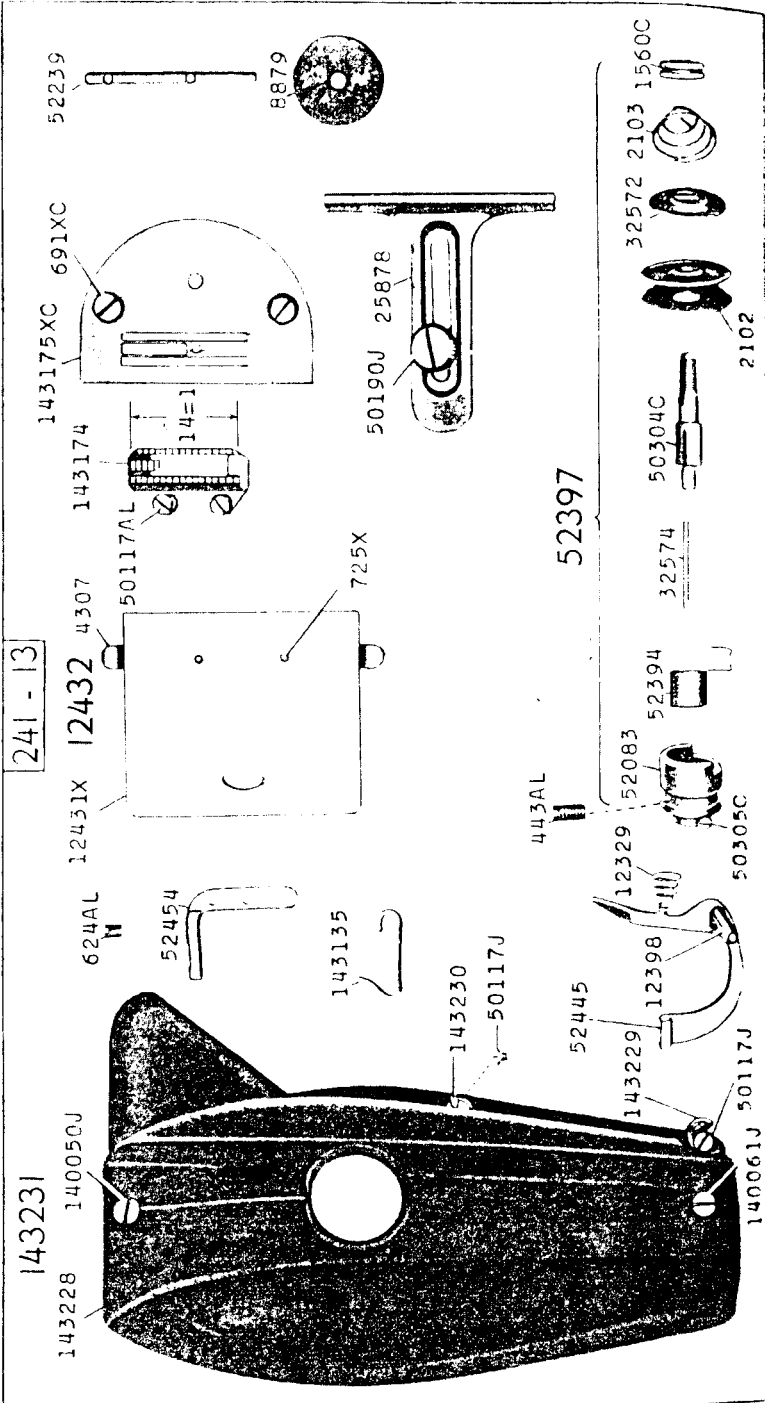

23280 - 2/3

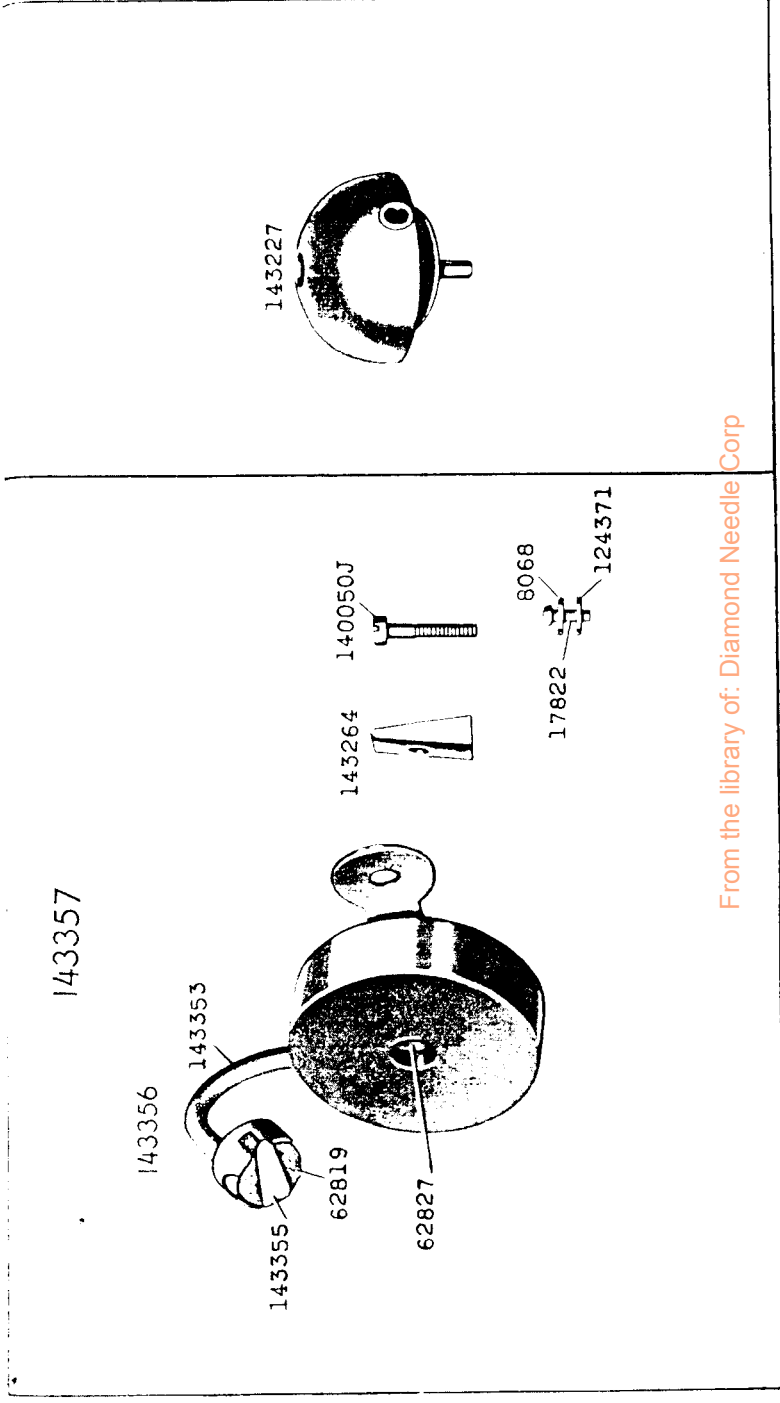

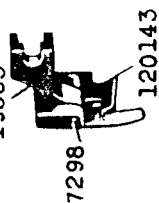
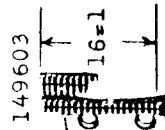
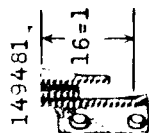
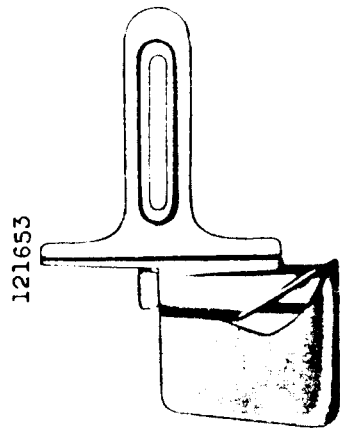
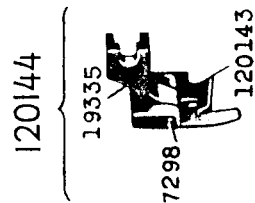
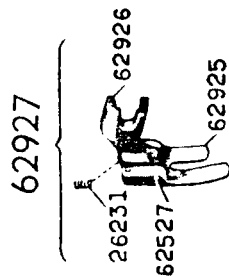
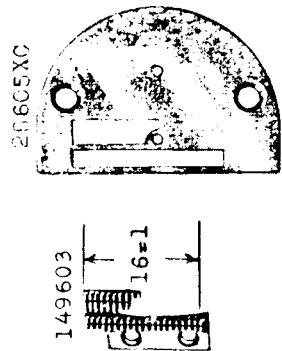
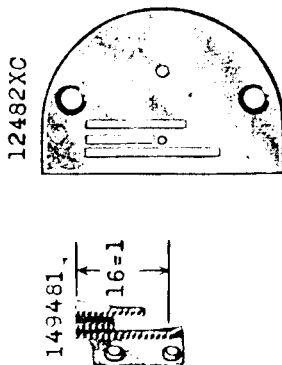
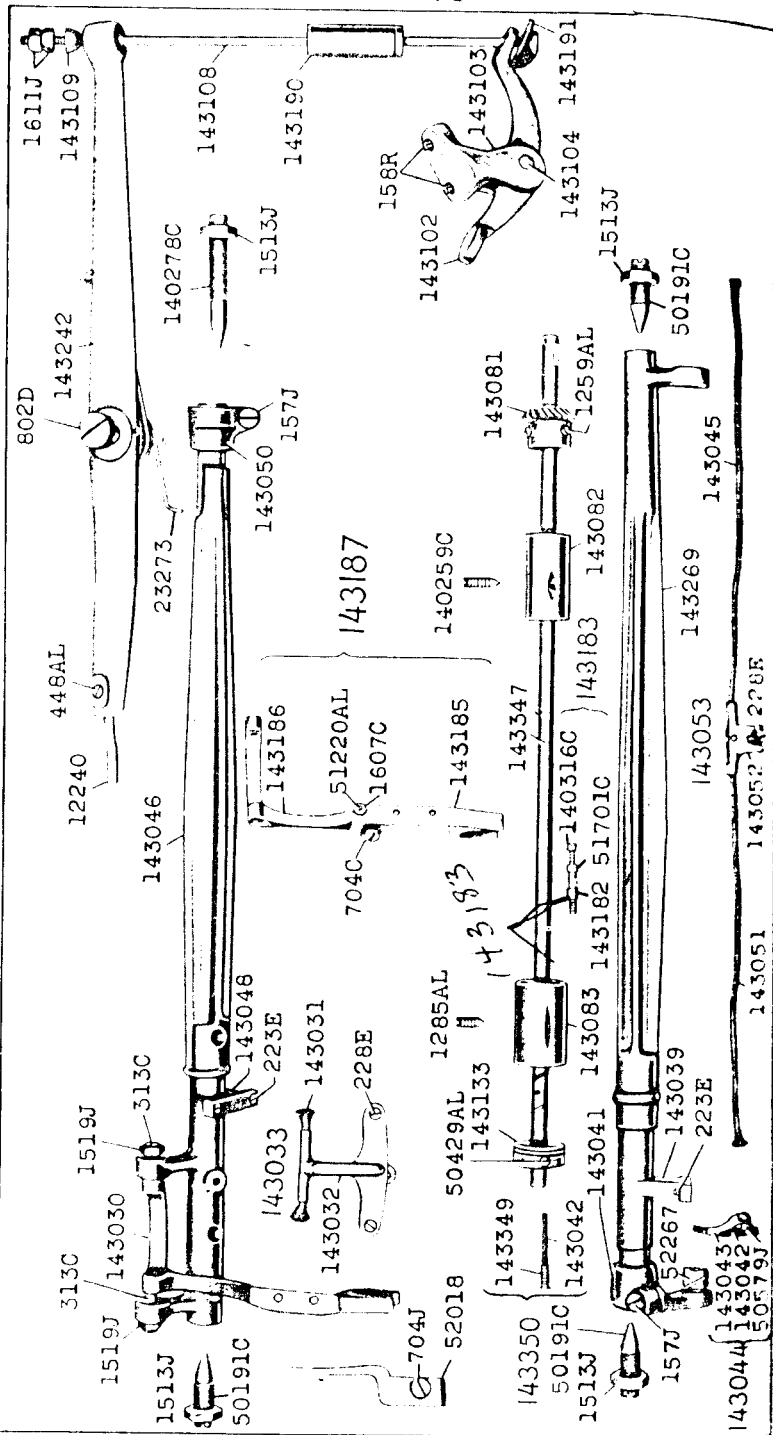

23283 - 1/3

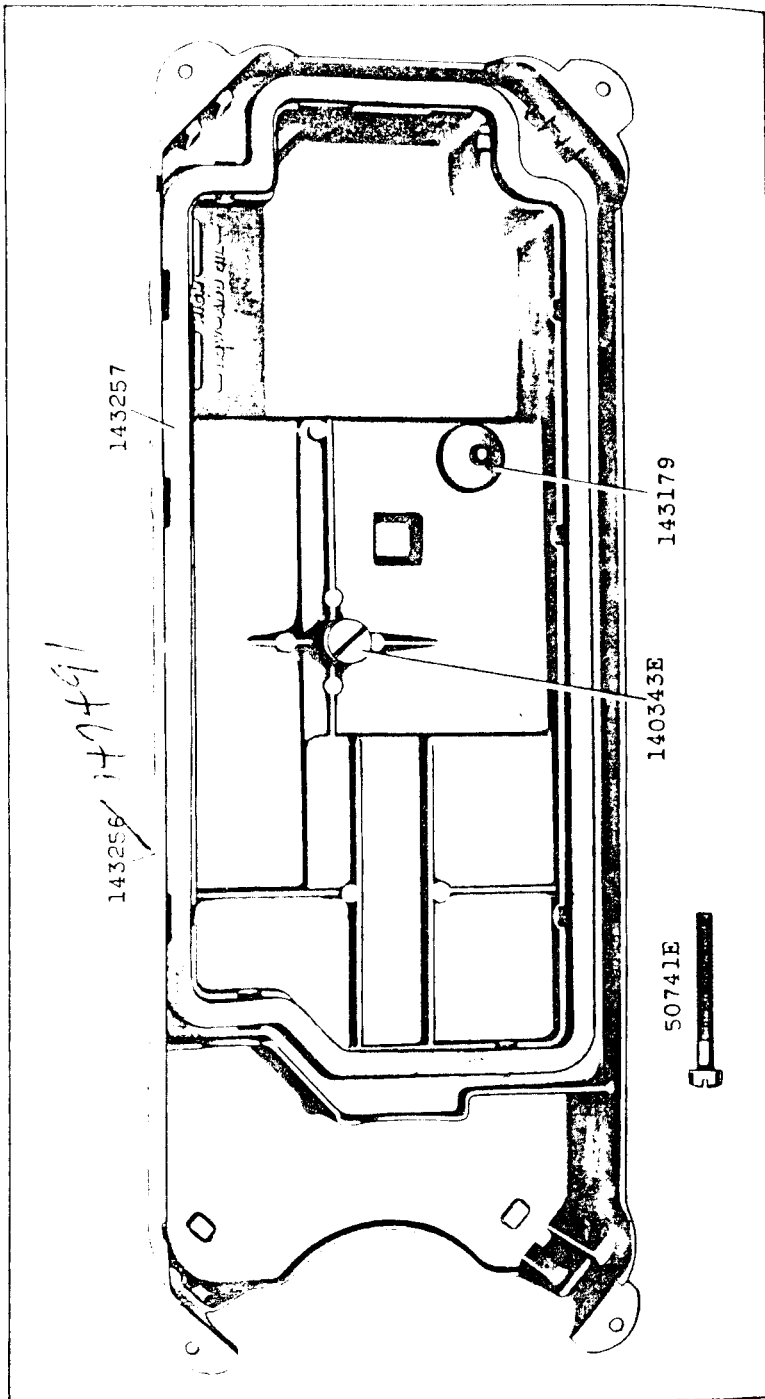

23284 - 1/2

143288

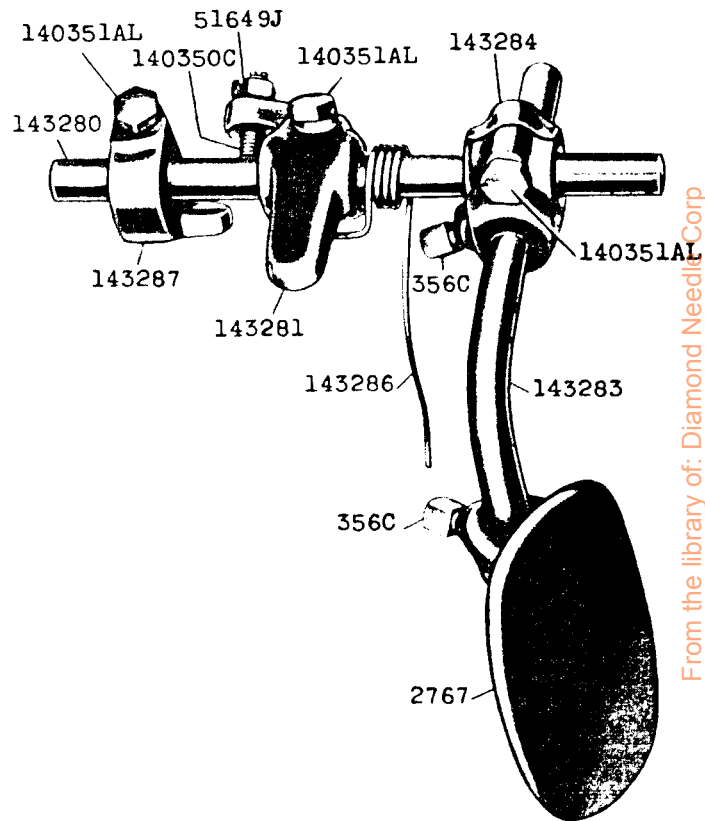

23285 - 2/3

160358XC

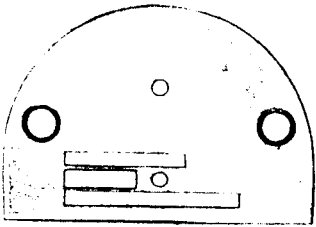

149357

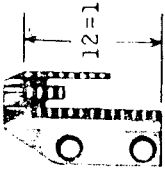

127260

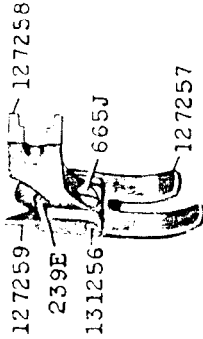

12422XC

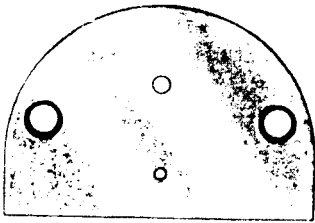

12298XC

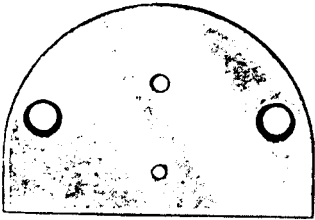

160342



23286 - 1/2

241 - II

143329

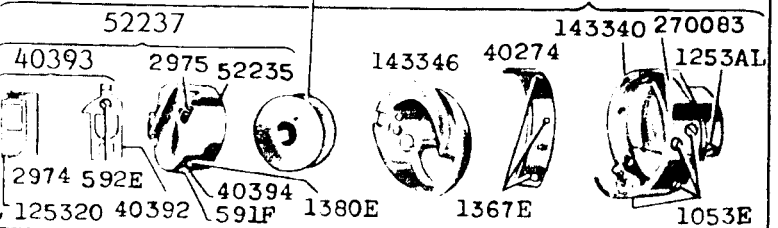
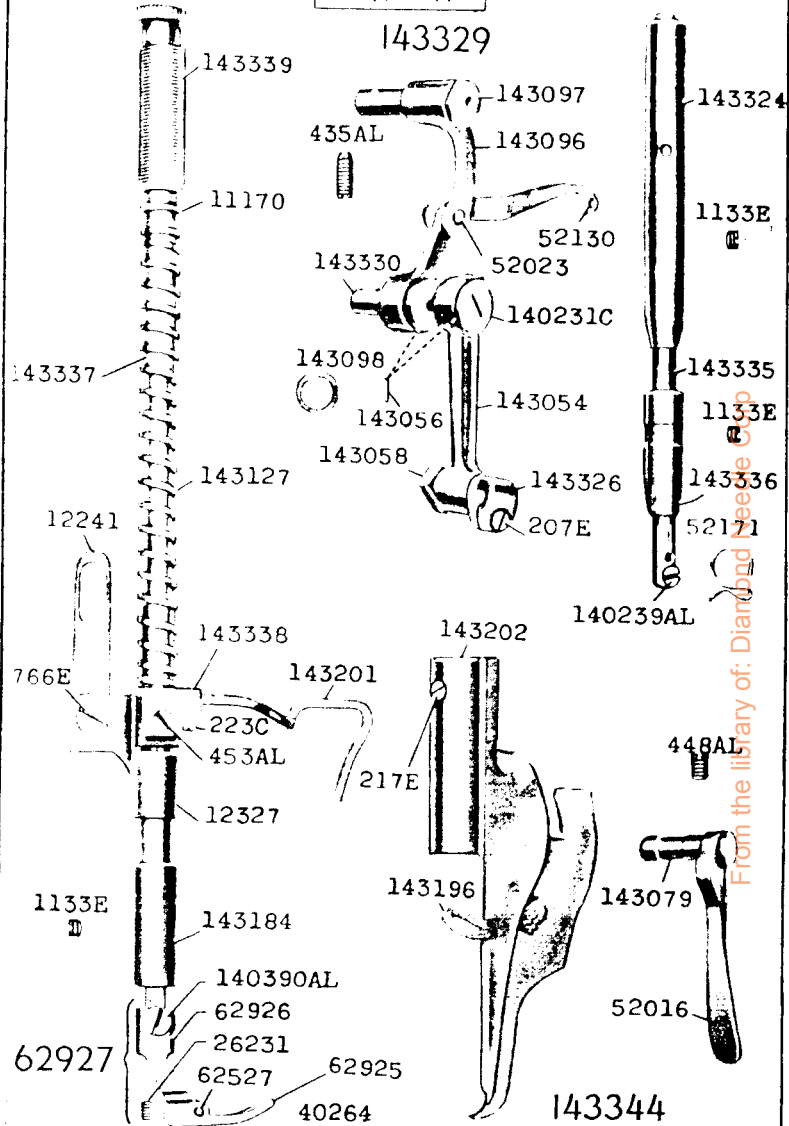

From the library of: Diabond Tools

23287 - 1/2

241 - 12

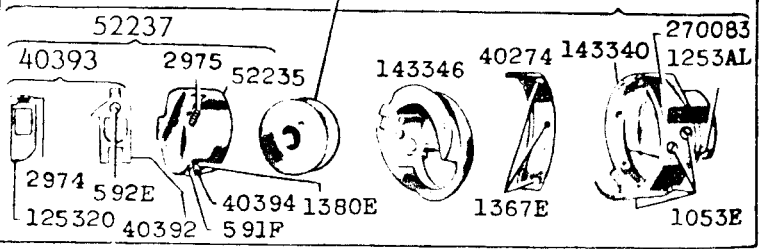
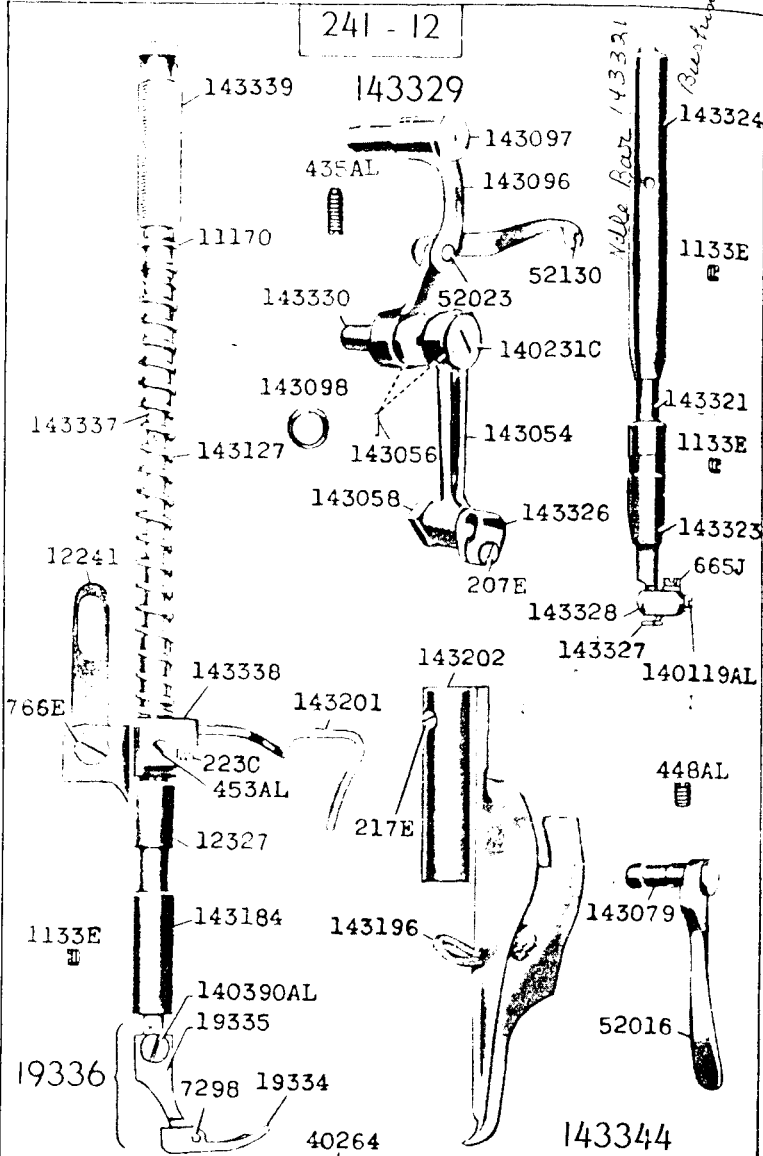

23288 - 1/2

241 - 13

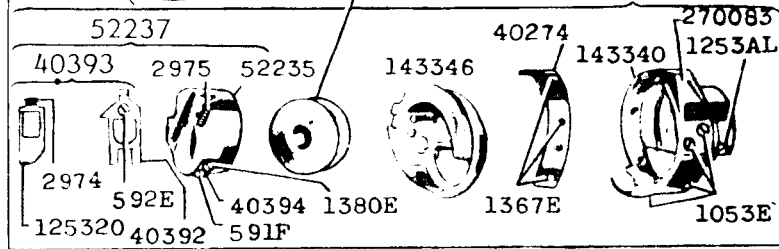
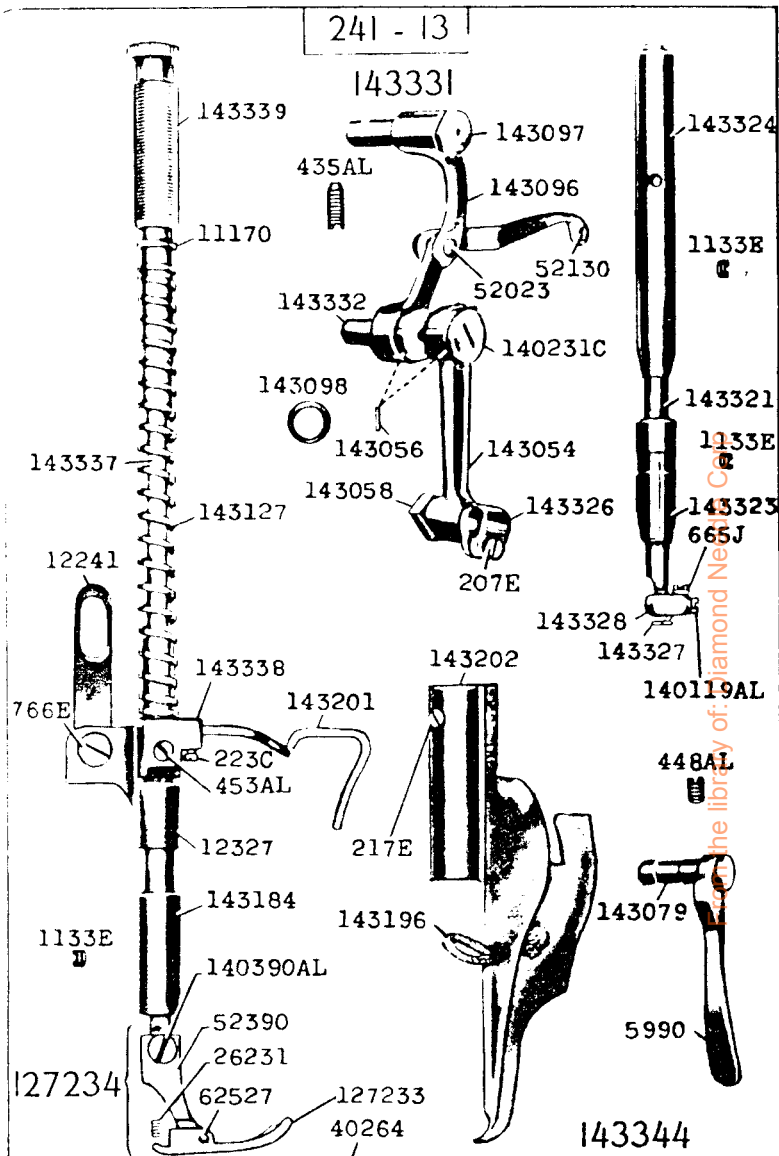

the library of Diamond Net Co.

23289 - 1/4

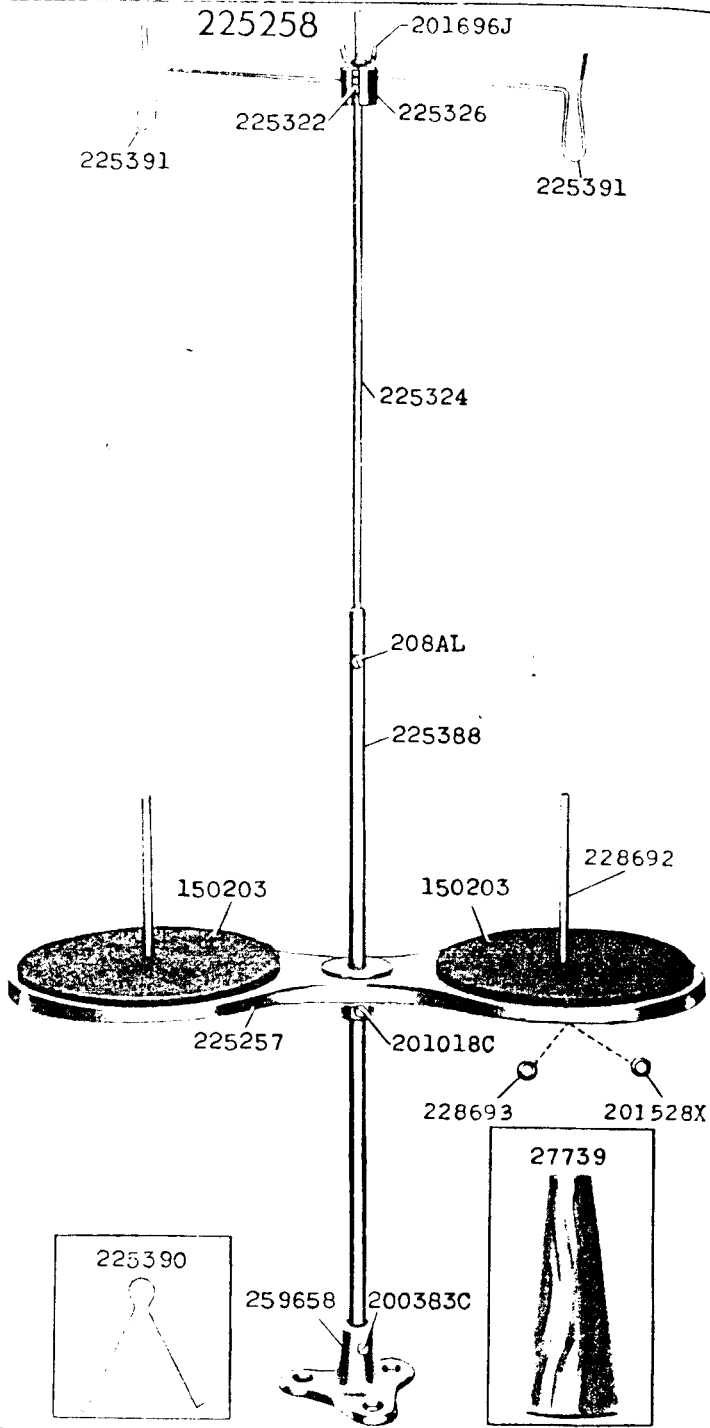

23290 - 1/4

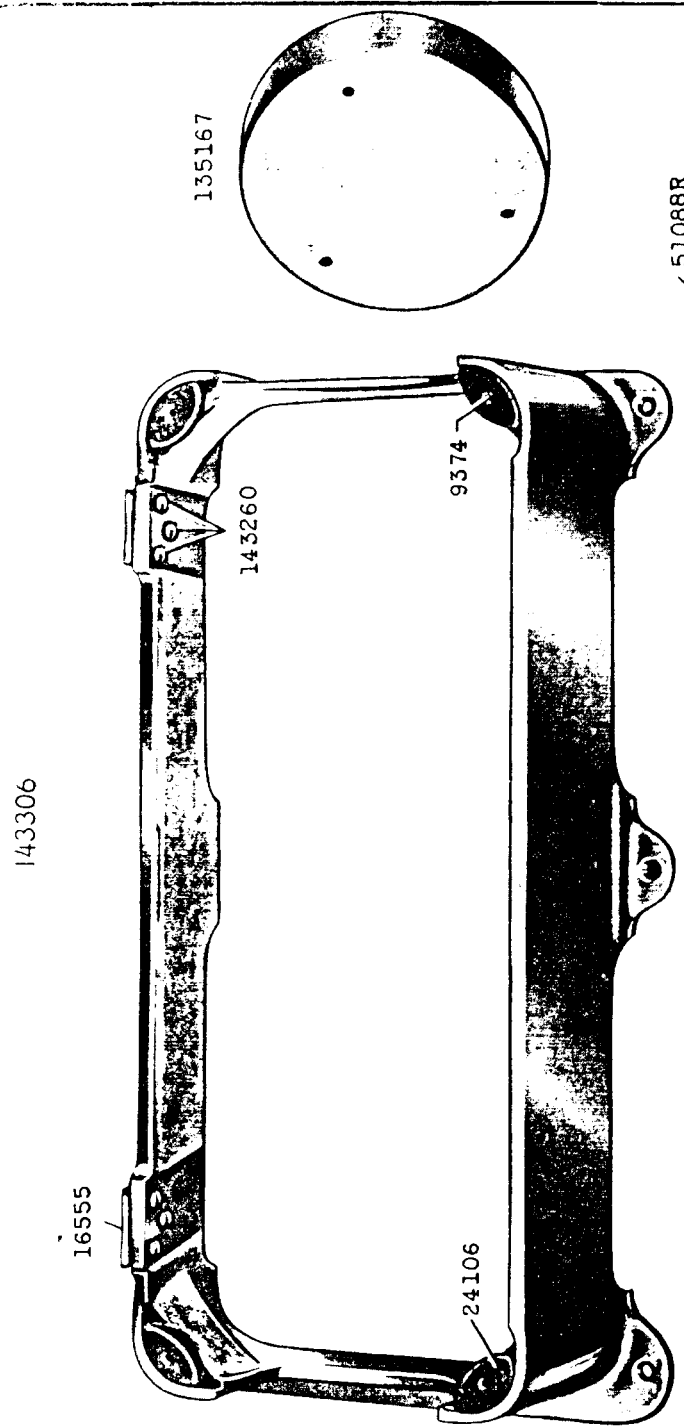

23291 - 2/3

241 - 11

121451

121123

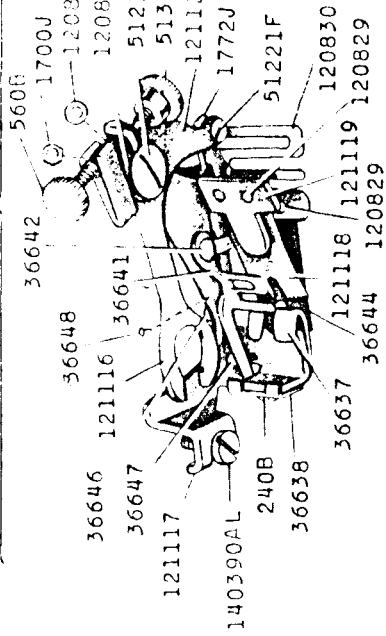

51272C



1981



36644



120829

120818

120819

44256XC

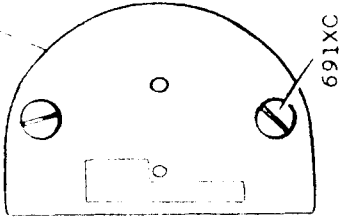

691XC

52056

140390AL



44253

16=1

50117AL

35245

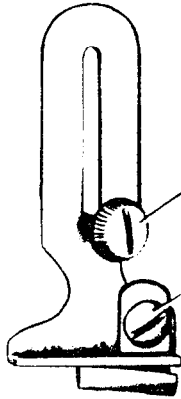

1443J

50190J

52056

140390AL



44253

16=1

50117AL

35245

44256XC

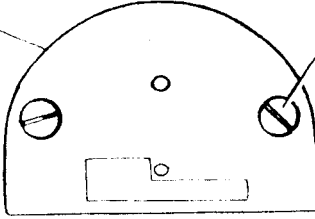

691XC

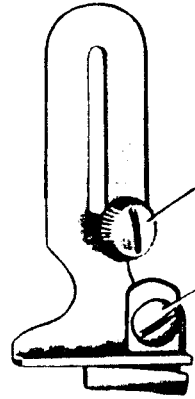

1443J

50190J

23292 - 2/3

241-12, 241-13

160449

121123

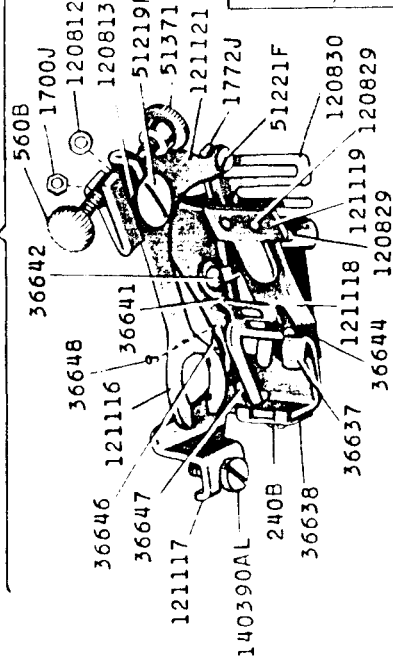

50203F



160448

36644



120829

120818

120819

121168

23293 - 2/3

241 - 12, 241 - 13

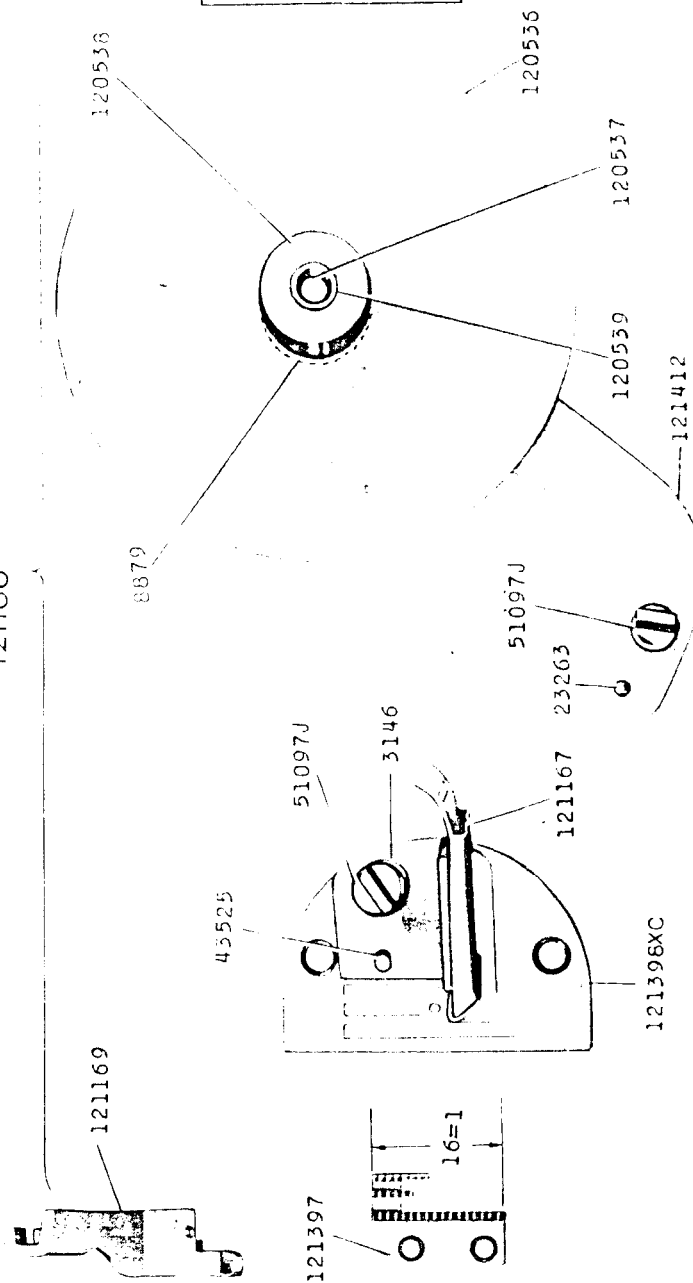

121871

23294 - 2/3

241 - 11

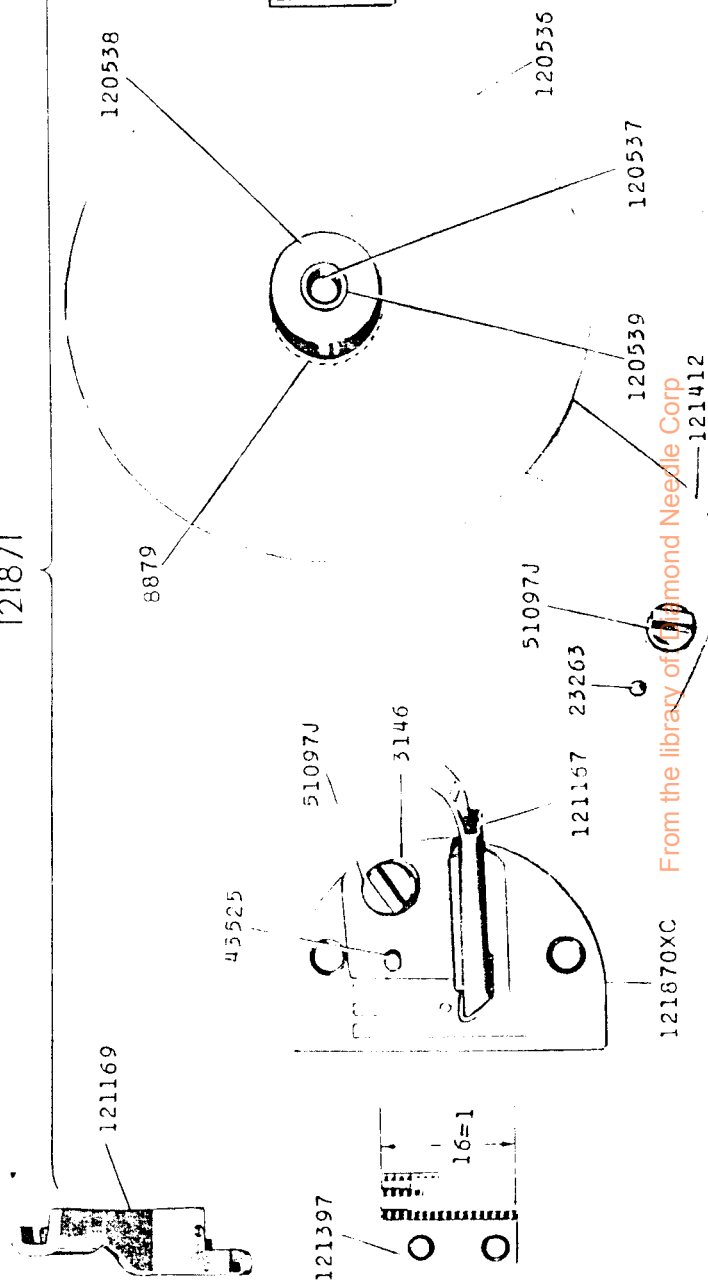

From the library of  Diamond Needle Corp

23295 - 2/3

241 - II

121890

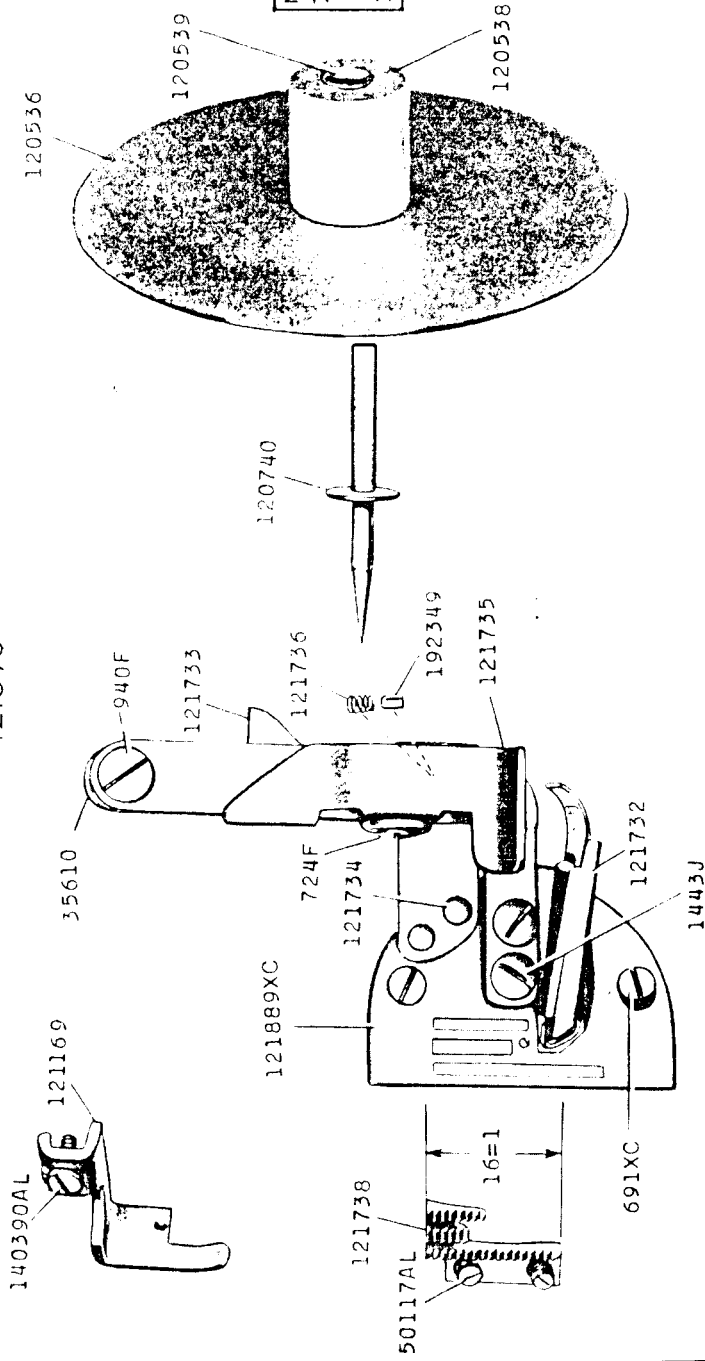

23296 - 2/3

241 - II

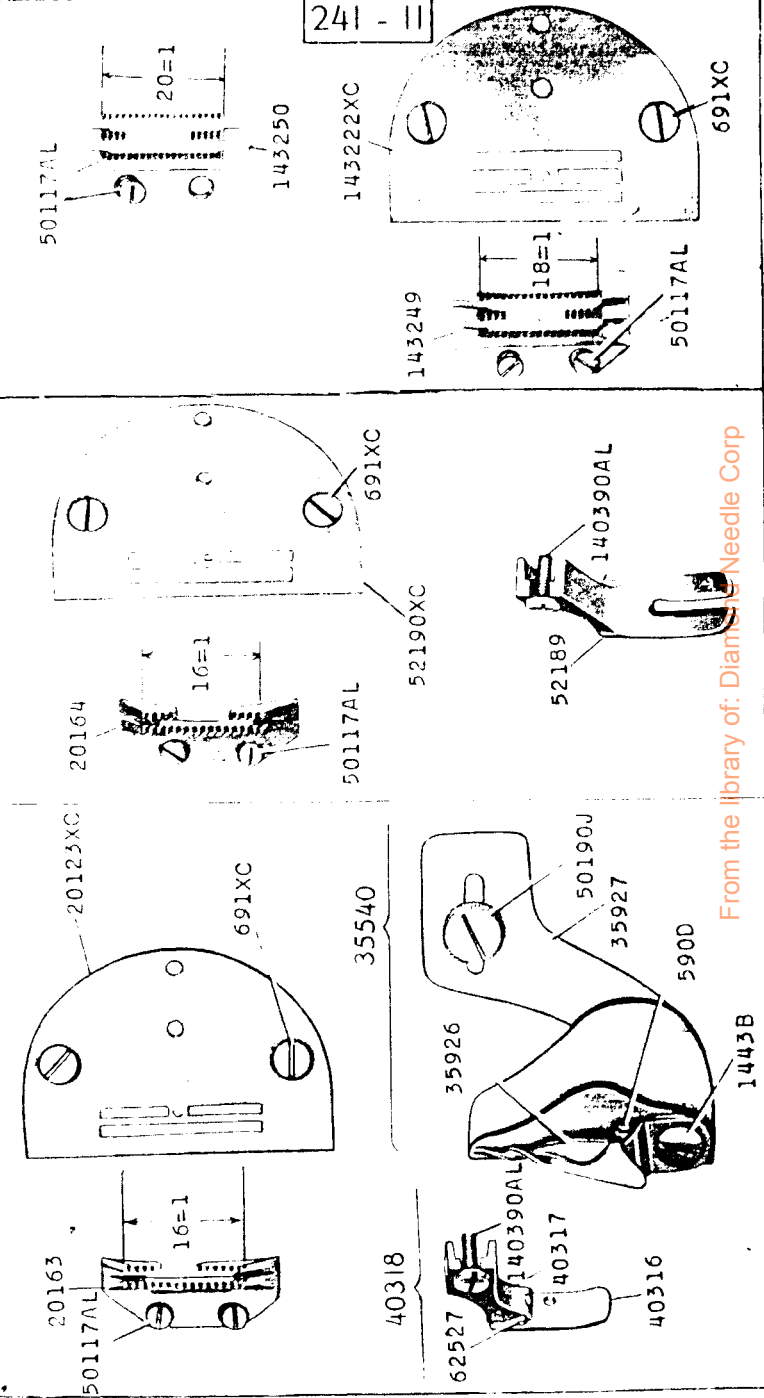

23297 - 2/3

241 - II

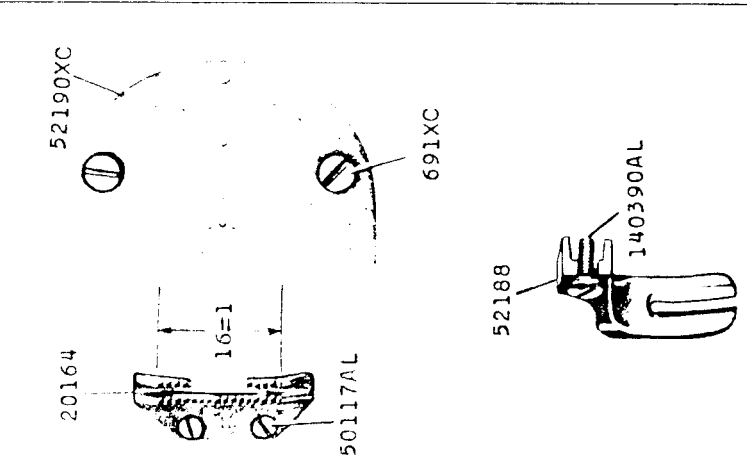
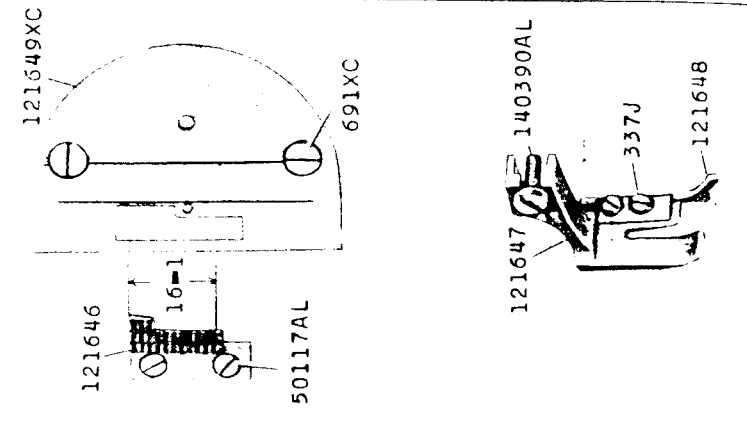
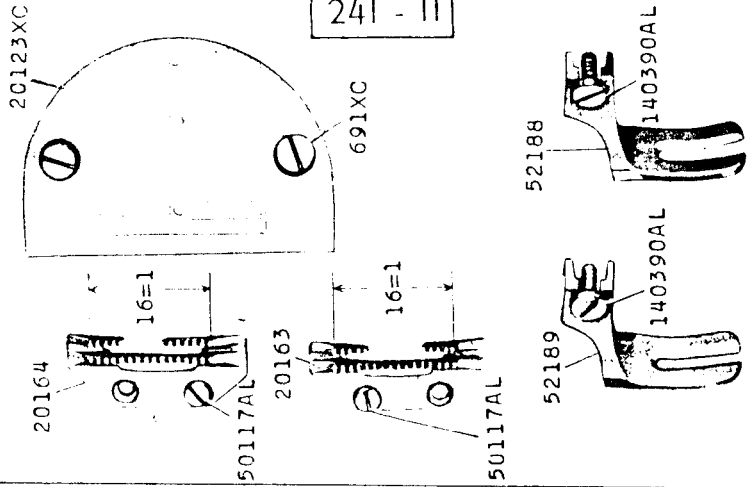

23298 - 2/3

19464 241 - 12, 241 - 13

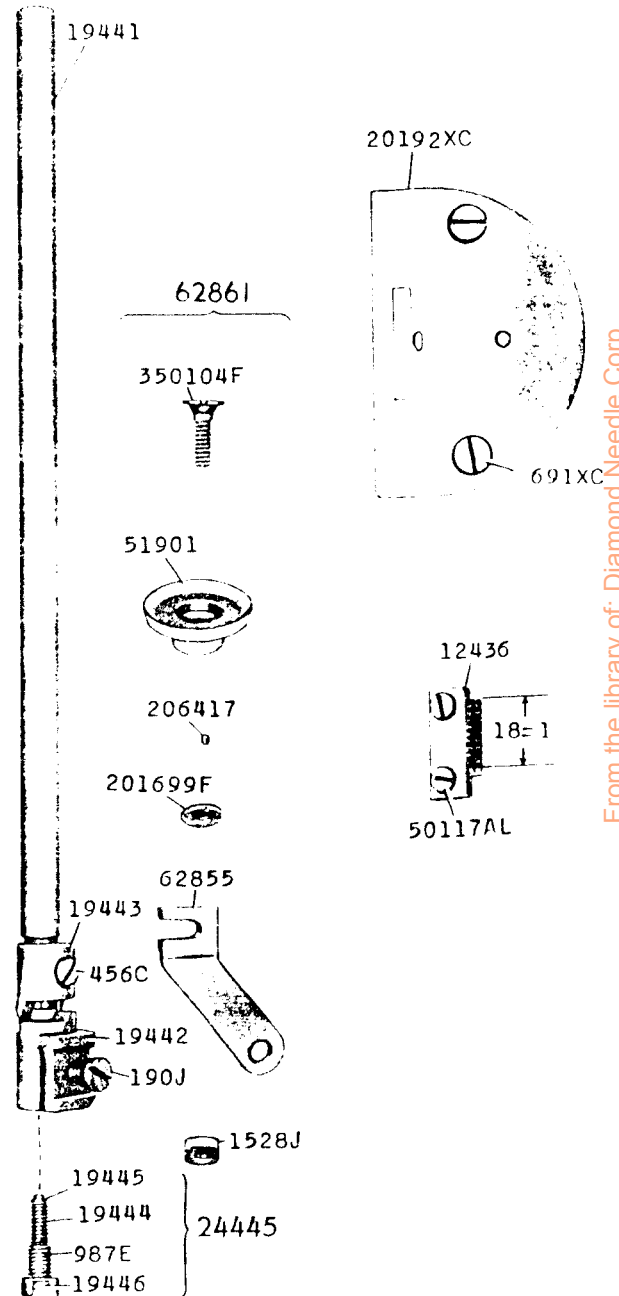

241 - 12, 241 - 13

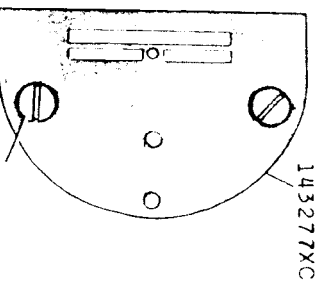
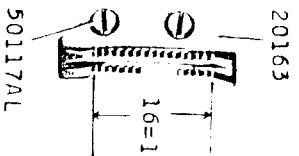

40318

140390AL

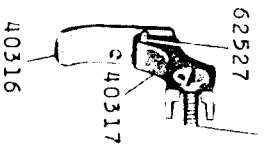

35540

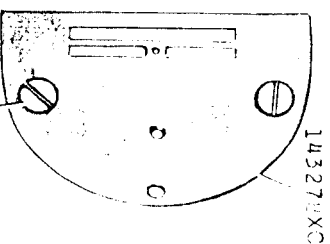
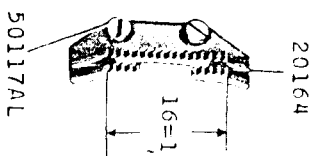
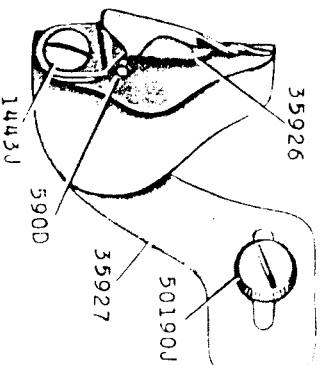

140390AL

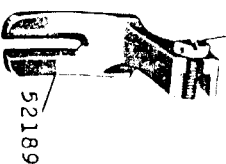

149450

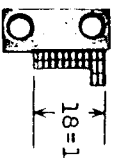

12464XC

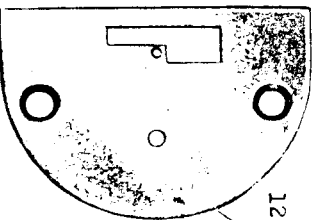

160344

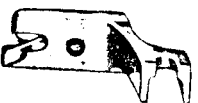

160343



160348



160346



160347

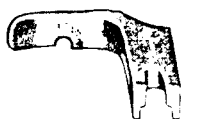

160335

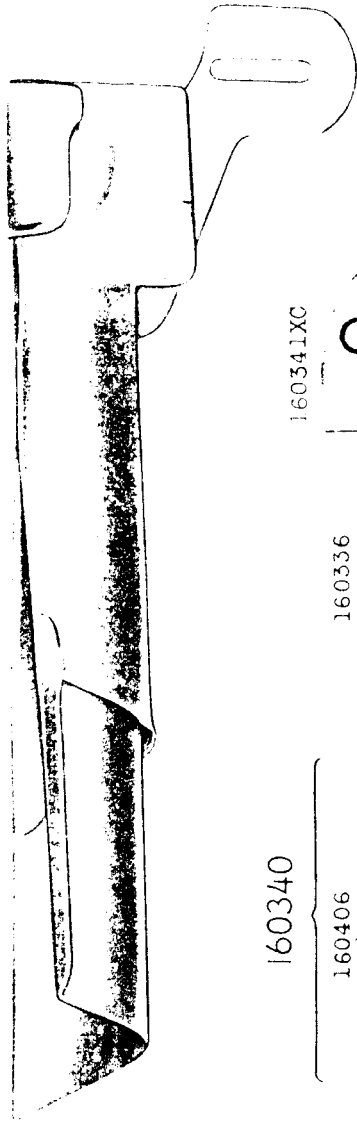

24351 - 2/3

241 - II

160340

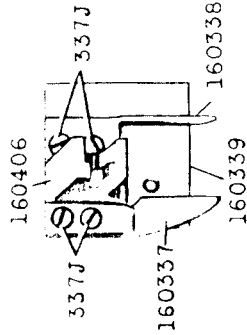

160341XC

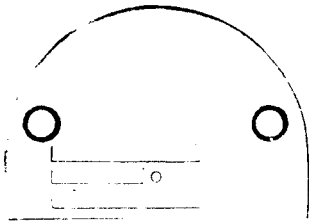

160336

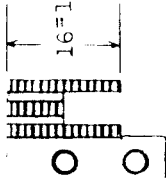

160317XC

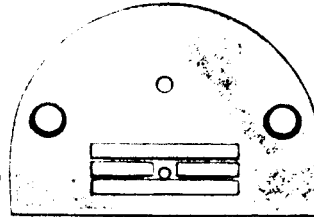

160318



19474

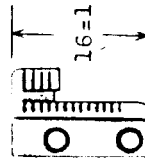

160332XC

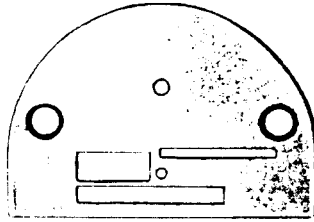

160316

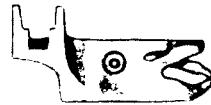

160331



24352 - 2/3

241 - II

160324

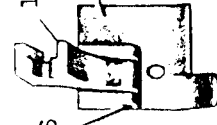

160323

160322

160326

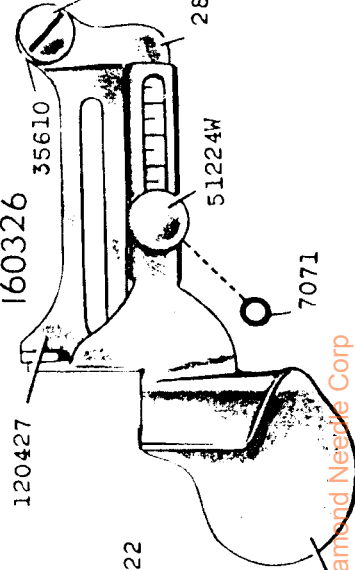

120427

35610

940W

28972

51224W

7071

26606XC

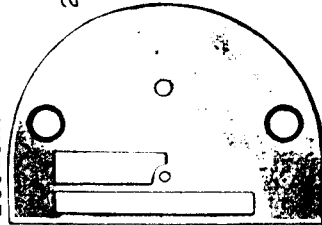

26603

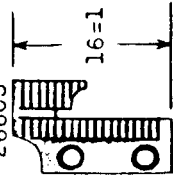

From the library of 60325 Iam and Neeske Corp

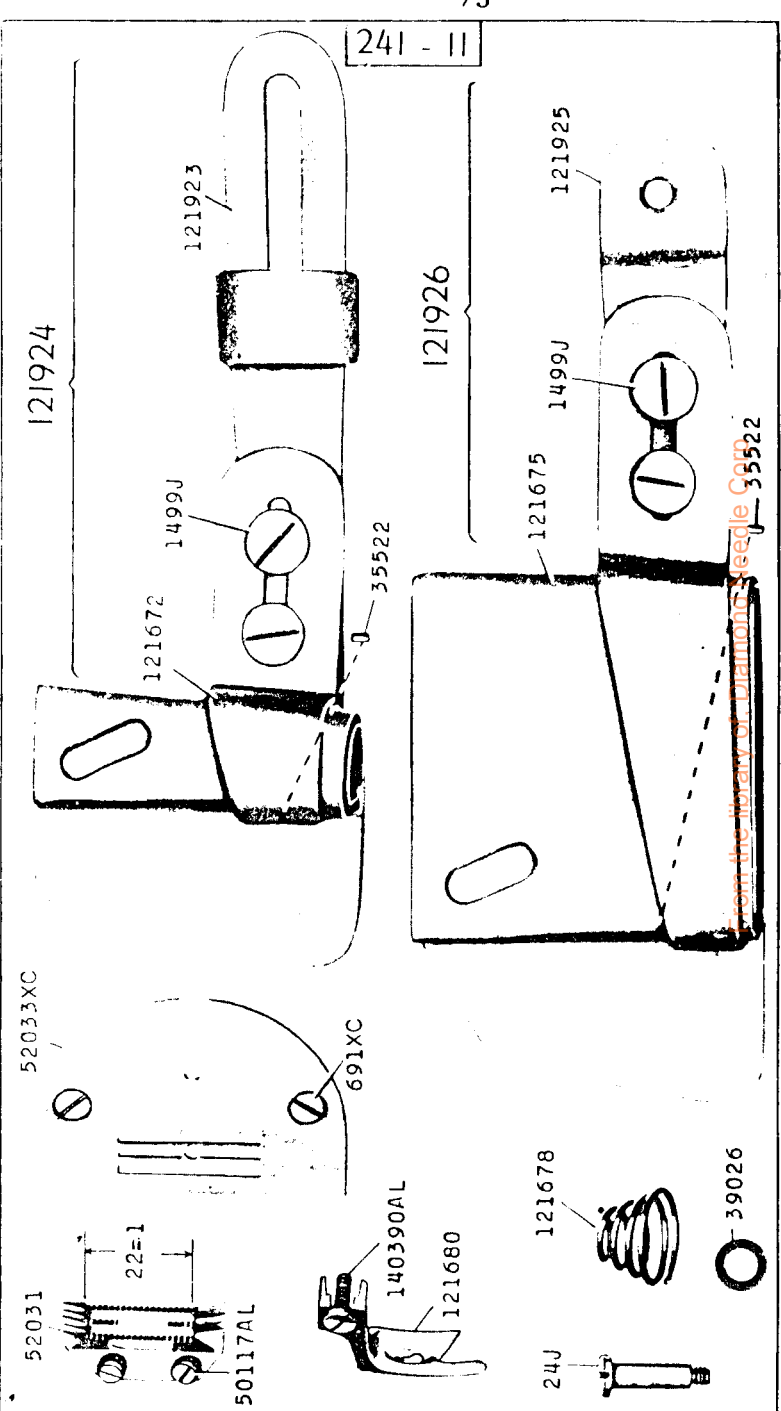
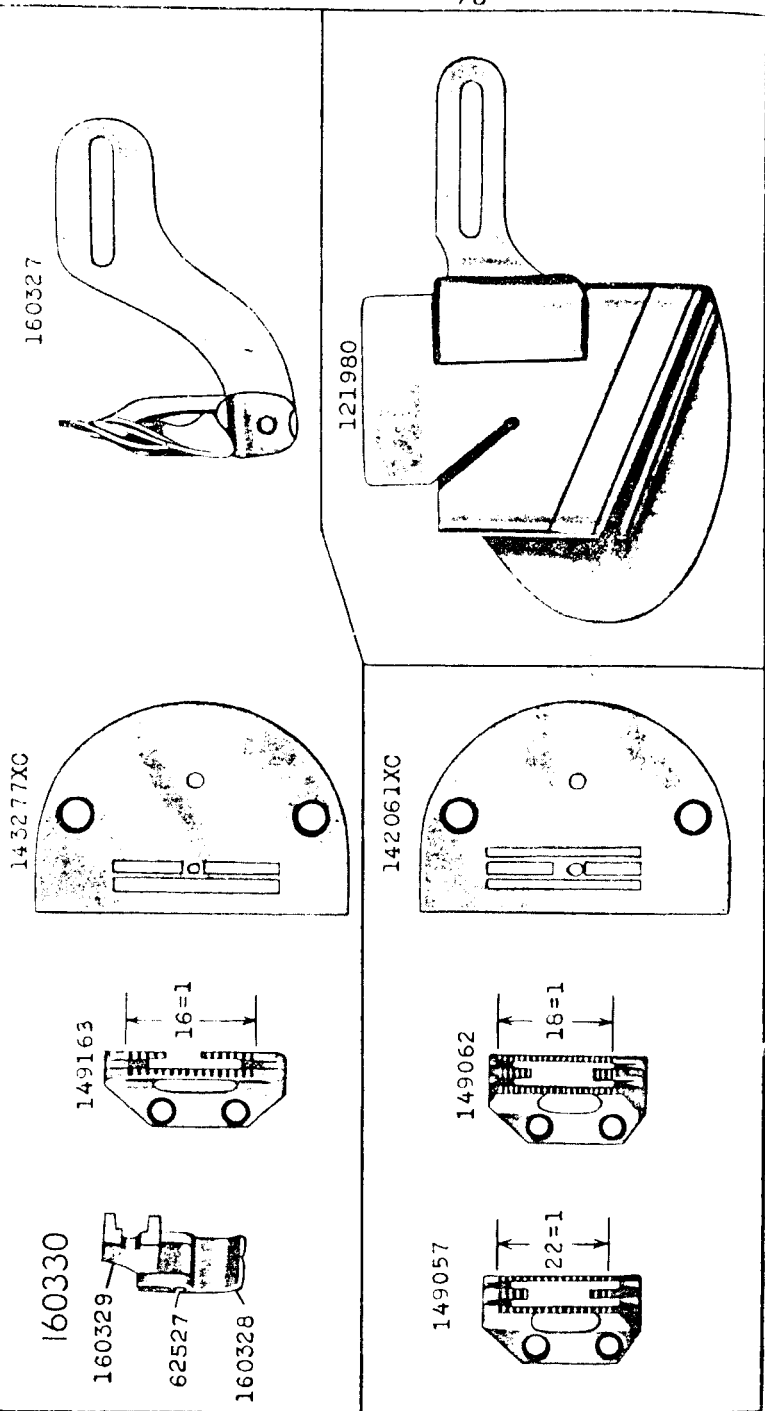

24355 - 2/3

24356 - 2/3

20150



24728

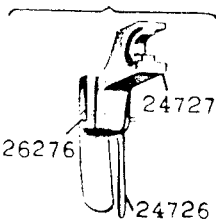

26650



28622



28726



28725

28909



28908

36069



139619



139618



139630

139628



665J

139629

160345



160349



160350



160351

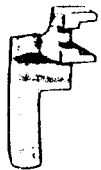

160352



160355

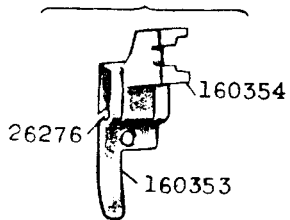

160356



121939



121940



121941



121942



121946

121944

62527

121943



121947



121950



121951



121949

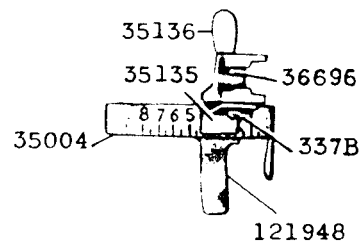

121952



35003

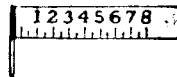

35004

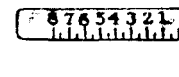

35005

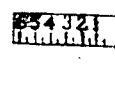

24357 - 2/3

241 - II

160333

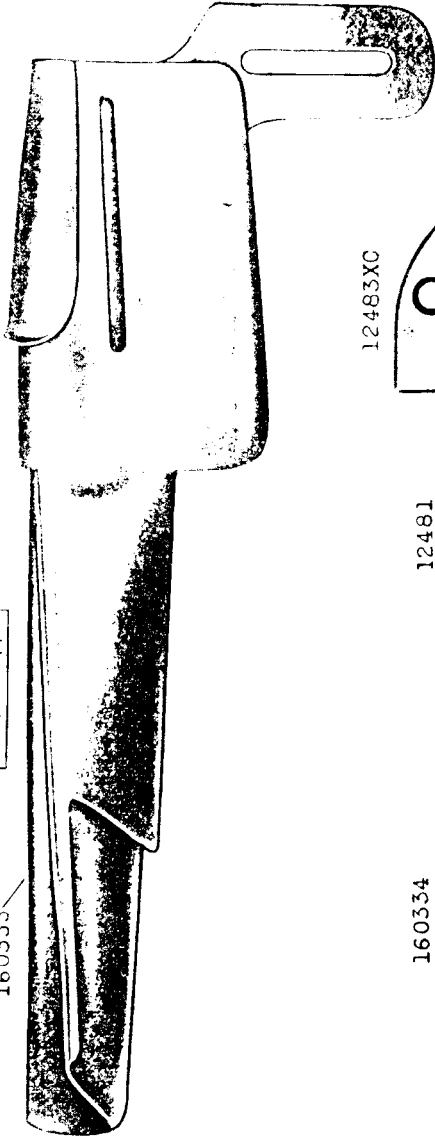

12483XC

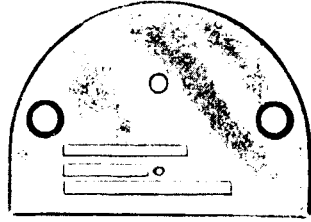

12481

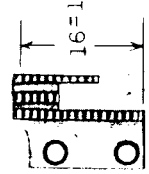

160334

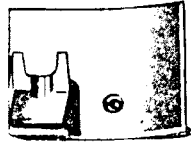

24358 - 2/3

241 - II

160321

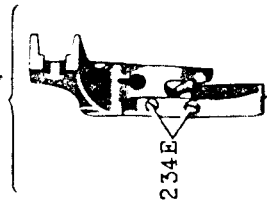

52031

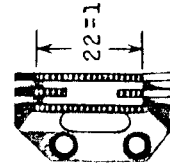

52033XC

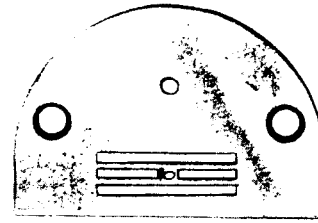

160320

160319

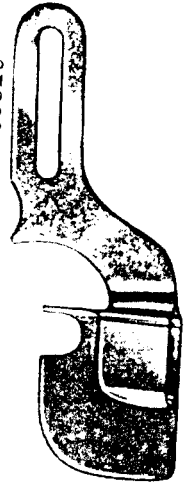

143243XC

121924

From the library of Diamond Needle Corp

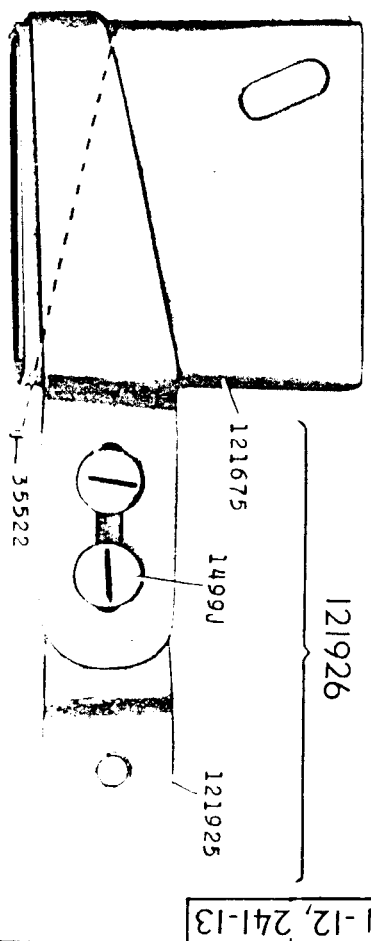
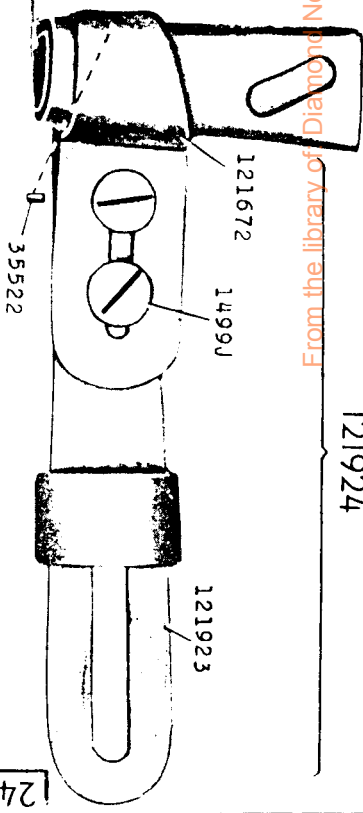
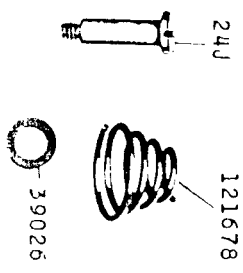
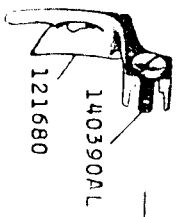
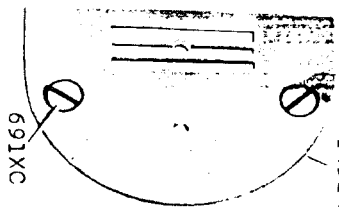
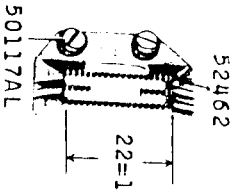

121926

241-12, 241-13

24359 - 2/3